

**UCL SWIFT**  
NORTH AMERICA

---

# SWIFT KF4A **USER MANUAL**

---

OPTICAL FIBER ARC FUSION SPLICER

*Read carefully before running KF4A*

[uclswiftna.com](http://uclswiftna.com)

This device complies with Part 15 of the FCC Rules. Operation is subject to the following two conditions: (1) This device may not cause harmful interference, and (2) this device must accept any interference received, including interference that may cause undesired operation.

Device Type	Notification
A Class Device (Broadcasting and communication device, commercial use)	Users need to understand that this device(A Class) has obtained EMI(Electromagnetic compatibility) and been designed to be used in places other than home.

**Telephone** 042 671 5607~8

**Homepage** [uclswiftna.com](http://uclswiftna.com)

**E-mail** [saleskorea@ilsintech.com](mailto:saleskorea@ilsintech.com)



# Contents

---

<b>I. SAFETY INSTRUCTION</b>	<b>3</b>
<b>II. PRODUCT SPECIFICATIONS AND COMPONENT</b>	<b>7</b>
2.1 Product specifications	7
2.2 Product package	8
<b>III. PRODUCT OUTLINE</b>	<b>10</b>
3.1 Function buttons	10
3.2 Component name	11
<b>IV. INSTRUCTIONS FOR USE</b>	<b>13</b>
4.1 Power supply	13
4.2 How to turn the power ON/OFF	15
4.3 Fiber cleaning	16
4.4 Inserting fiber to protecting sleeve	16
4.5 Fiber stripping	17
4.6 Fiber cleaning	20
4.7 Fiber cleaving	21
4.8 KF4A Sleeve-Heater	26
4.9 Splice procedure	29
4.10 Removing the spliced fiber	30
4.11 Heating protection sleeve	30
4.12 Use of Work Belt	31
<b>V. MAINTENANCE OF SPLICE QUALITY</b>	<b>32</b>
5.1 Cleaning and Inspection before splice	32
5.2 Regular inspection and cleaning	34
<b>VI. MENU</b>	<b>36</b>
6.1 Splice	47
6.2 Heater	55



6.3 Stripping	60
6.4 Splice result	64
6.5 Option	66
6.6 Optical module	70
6.7 Calibration	72
6.8 Electrodes	77
6.9 Setting	81
6.10 Information	85
<b>VII. ERROR MESSAGE</b>	<b>88</b>
7.1 Too Dirty Fiber	88
7.2 Replace Fiber.	88
7.4 Fiber Over Angle	89
7.5 Loss Limit Over.	90
7.6 Fiber Thin Error	90
7.7 Fiber Thick Error	90
7.8 Bubble error	91
7.9 Cleaved Surface Error	91
<b>VIII. SPLICING PROBLEM SOLVING</b>	<b>92</b>
8.1 When loss is high	92
8.2 Abnormal splicing operation	93
<b>IX. PROBLEM OCCURRENCE AND QUESTION</b>	<b>94</b>
9.1 Power	94
9.2 Splice	95
9.4 Others	97
<b>X. WARRANTY AND REPAIR</b>	<b>99</b>
10.1 Information necessary for repair	99
10.2 Transportation	100



# I. Safety instruction

---

Swift KF4A is designed to be used conveniently on both indoor and outdoor work sites. Its use is easy and simple but make sure to read this instructions prior to prevent accidents and malfunctions before using Swift KF4A. This user guide provides information necessary for safe operation.

**Keep this users guide with the product at all times.**

Ilsintech does not take any responsibility for the equipment's damage and personal or physical loss incurred due to improper use or alteration.

## Warnings

When any of the following occurs during the use, turn off the power immediately and contact to Ilsintech.

- Smoke, disgusting smell, noise or abnormal overheating.
- When a foreign substance or liquid falls into the equipment
- When the splicer falls down or it is damaged

Regarding AC power cord, use the one provided with Swift KF4A. If a power cord other than provided is used, it may incur fire, electrical shock or injury.

Do not touch the Electrodes when power is on. High voltage and high temperature generated from Electrodes may incur serious shock or burn.

Connect the provided AC power cord to a battery. Check if there is any foreign substance on the terminal before connecting it to the AC power socket. Incomplete splice may incur smoke, electric shock, fire, damage of equipment, serious injury and even death.

## Warninas

Use proper power voltage.

AC power for the adapter is AC100-240V, 50~60Hz.

Test the AC power before use. When output voltage of AC power is high or abnormal frequency is generated, the product is damaged and serious injury or even death may be incurred to the user.

AC output voltage should be measured using circuit tester before connecting AC power cable and regular inspection should also be conducted.

Do not pull AC power cord with excessive force, apply heat or transform it.

When a damaged power cord is used, it may incur fire or injury.

Use 3-plug AC power cord and do not ever use 2-plug power cord, cable or plug.

Do not touch AC plug, AC power cord or splicer with wet hands. It may incur electric shock.

Do not disassemble AC adapter, battery or Swift KF4A. Deformation may incur fire, electrical shock or injury.

Refer to the following when using the battery.

- When an improper battery which is not provided by Ilsintech is used, it may incur smoke, damage of equipment, burn, injury or even death.
- Do not dispose the battery into fire.
- Do not charge the battery near flame.
- Do not give an excessive shock to the battery.
- When the battery does not completely charge in 2 hours or the green LED is not turned on, stop charging immediately and contact Ilsintech.
- Do not put anything on AC adapter while charging.

Use exclusively the AC adapter provided. Do not use another AC power cord or battery. Excessive current may incur equipment damage or injury.

Do not use Swift KF4A where there is harmful gas or flammable liquid. Explosion or fire may be incurred due to electrical arc.

## Warnings

Do not use compressed air or compressed gas when cleaning Swift KF4A.

Inspect carry case belt before transportation. If the carry case is dropped due to damage on the belt, it may incur equipment damage or injury.

Wear safety goggles when working on splicing. It is very dangerous if a piece of fiber chips get in skin or eye.

Do not use Swift KF4A around high temperature or flame. It may incur injury or equipment damage.



: Caution for high temperature



Do not spray Freon gas



: Caution for high voltage

## Cautions

Do not touch sleeve heater or protecting sleeve while sleeve heater is operating or right after heating is completed. It may incur injury due to high temperature.

Do not put Swift KF4A in an unstable place. When the equipment is dropped, it incurs injury or equipment damage.

Swift KF4A should be accurately adjusted and treated in alignment. Do not give it a strong shock, either.

Use a carry case to carry or to keep Swift KF4A. The carry case keeps the equipment from humidity, vibration and shock during storage and transportation and prevents possible damage to KF4A.

Replace the Electrodes in timely manner referring to the following.

- Designated electrodes should be used.
- Place new Electrodes to the right position.
- Replace the Electrodes in pairs.

Abnormal arc is incurred when not following the aforementioned caution. It may incur equipment damage or an abnormal splice.

Do not use any chemical other than ethyl alcohol (96% or higher) to clean lens, V-Groove, LCD monitor and main body.

Using other chemicals may incur deformation, discoloration or deteriorated performance.

Do not keep the equipment in any environment where the high temperature or high humidity prevails. It may incur equipment damage.

Swift KF4A should be inspected by a qualified expert, or it may incur fire or electric shock.

Discuss with Ilsintech to use the service.



## II. Product specifications and component

### 2.1 Product specifications

Item	Description
Fiber alignment	IPAAS clad alignment method
Applicable fibers	0.25mm, 0.9mm, 2.0mm, 3.0mm Indoor cable
Number of fiber core applicable	Single
Fiber diameter	Clad diameter: 125 $\mu$ m, Coating diameter: 150 $\mu$ m~3mm
Cleaved length	5.0mm~16mm
Splice mode	Splice mode: 300, Heater mode: 100
Splice loss	SM: 0.02dB, MM: 0.01dB, DS: 0.04dB, NZDS: 0.04dB
Reflection loss	> 60dB
Splice time	About 7 seconds (Quick mode)
Sleeve heating time	9 seconds (IS-45 sleeve, IS-45 mode), 13 seconds (IS-60 sleeve, IS-60 mode)
Applicable protecting sleeve	40mm, 60mm, 32mm or 28mm (For SOC)
Data storage	Internal memory capable of saving 5,000 times (Saving 5,000 images)
Tension test	1.96N ~ 2.25N
Size	132(W) x 212(L) x 73(H)mm
Weight	1.5kg
Fiber magnification	X/Y : 110X, Max 220X



Power	DC lithium polymer battery (DC 14.8V, 3400mAh), 100~240V AC adapter
Battery capacity	Approximately 200 cycles
Electrodes life	Up to 38,000 splices
Terminals	USB, RCA, external power(DC 12V vehicle cigar jack splice)

## 2.2 Product package

### 2.2.1 Standard package

Item	Model name	Quantity
Fusion splicer	Swift KF4A	1
Battery adapter	FY1701000	1
Spare Electrodes	EI-24	1 set
Battery	KF-3400	1
Cooling tray	CT-01(40mm)	1
Users Guide	-	1
Carry case	Soft Bag (ILST-SS03(L))	1
Screw driver	LD-3300	1
Fiber Hoder	-	1 set
USB cable	-	1













## 2.2.2 Optional package

Item	Model name
Battery	KF-3400
Cleaver blade	BI-05
Electrodes	EI-24
Fiber holder	HS-250, HS-900, HS-2.5, HS-IN, HF4-SC/FC, HF4-ST, HF4-LC, LS-900 (Choose one)
Sleeve	S09-C, S09, S30-C, S30
Sleeve clamp	SC-01
Work belt	WB-01
SOC connector	SC, LC, FC, ST [See Ilsintech website.]
Manual Stripper	CF-02
Carrying case	Hard Case (HC-11)
Cigar jack	DC 12V vehicle cigar jack splice
Optical Power Module (Optical power meter + VFL)	

## III. Product outline

### 3.1 Function buttons

Button	Description
	Press and hold about 1 second to turn the power ON/OFF. Press and hold about 1 second when power is on and splicer turns off.
	Move the cursor to the left. Move fiber on manual mode and adjusts camera's focus. It loads stripping popup menu.
	Move the cursor to the right Move fiber on manual mode and adjusts camera's focus. It loads VFL (Shortcut)
	Move the cursor upwards. It selects each motor on manual mode. It loads splice popup menu.
	Move the cursor downwards It selects each motor on manual mode. It loads heater popup menu.
	Initialize the splice function.,It goes back to the menu screen.
	Complete a selection It goes to the next step on the menu screen.
	Splice execution.
	It goes back to the initial screen. It initializes splice function.
	Turn on the stripper.,When it is ON, the lamp on the left is in red. Press once more when it is ON and the heater is turned off.
	Turn on the heater. When it is ON, the lamp on the left is in red. Press once more when it is ON and the heater is turned off.

### 3.2 Component name

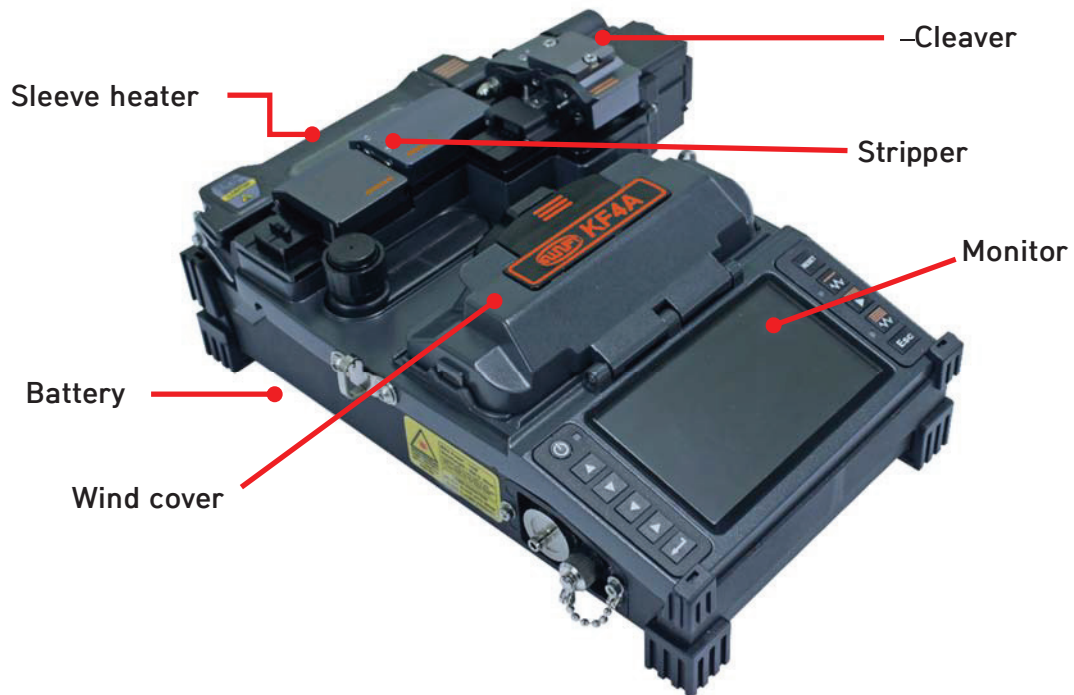



Remaining battery indicator

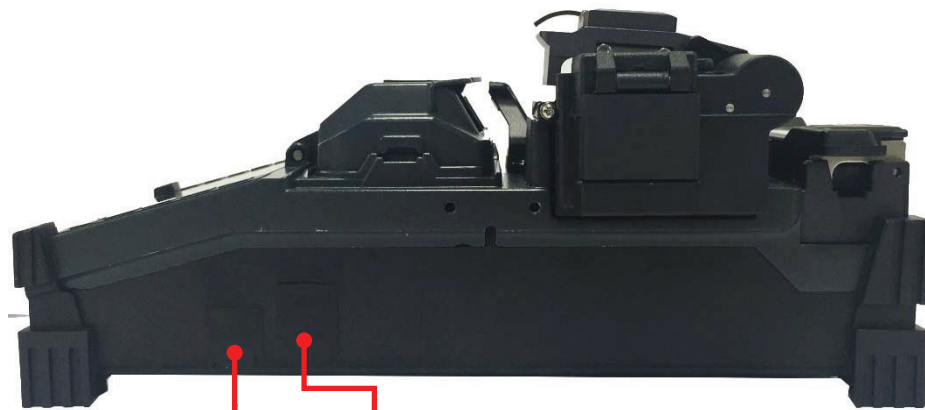

USB

DC OUT

Heater

Heater cover



## IV. Instructions for use

The following is the initial screen of Swift KF4A. For accurate splice result, splice mode, stripping mode and heater mode should be properly selected. Basic information on Swift KF4A is displayed on the initial screen. Check whether the proper mode is selected before splice.

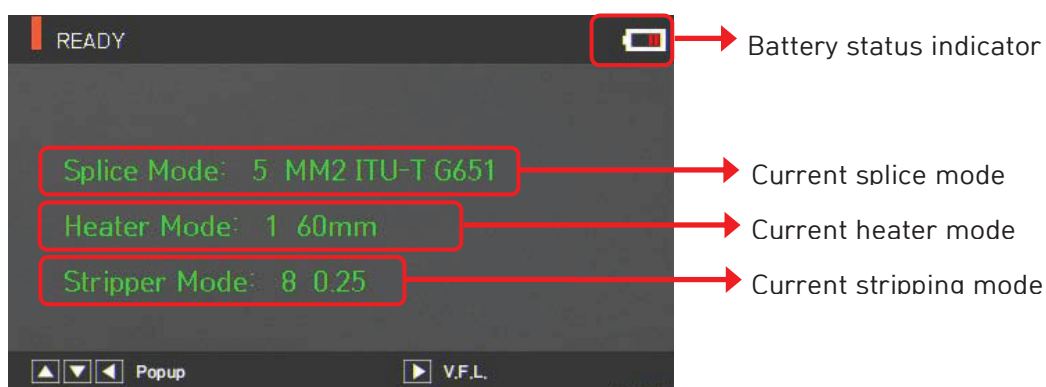

### 4.1 Power supply

Battery pack is built in at the battery chamber. Loosen the bolts at the bottom cover and exchange battery. Please be cautious when you detach the battery from the chamber.

#### 4.1.1 Built in battery



## 4.1.2 Battery charging

Make sure you check the voltage, frequency and then the DC cable of AC/DC adaptor connects to the DC jack of the battery before charging the battery

When the battery is fully charged, LED will turn green and power is disconnected, activating protection circuit to avoid overcharge. The power is turned back on as the battery needs to be charged and charging resumes when the DC cable of adaptor is connected to the DC jack of the battery.





## 4.2 How to turn the power ON/OFF

To turn on the power of Swift KF4A, press  and hold about 1 second with the wind cover closed. After the entire functions including motors are initialized, the initial screen is subsequently displayed as follows. For accurate splice, splice mode and heater mode should be properly selected. Current splice mode, stripping mode and heater mode are displayed at the bottom of the screen.

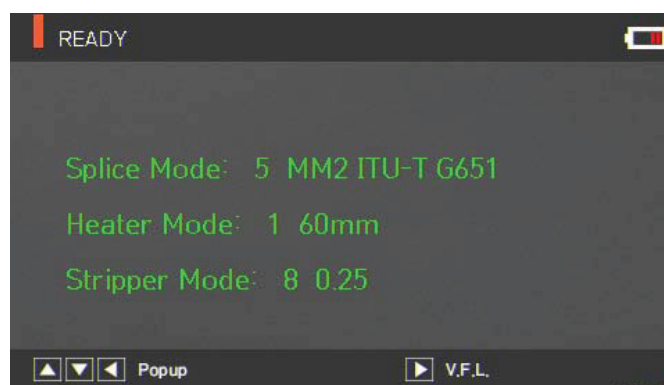

### 4.3 Fiber cleaning

Wipe fiber clean with soft cloth or cotton moistened with alcohol. Fine dust on the surface of the fiber may increase loss after splice and incur damage on the fiber after heating.

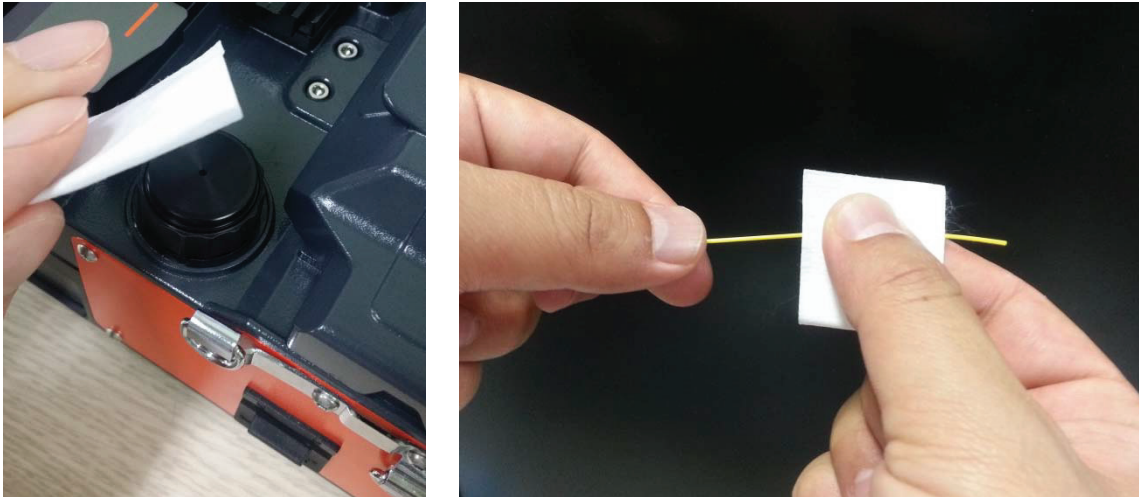

### 4.4 Inserting fiber to protecting sleeve

Put fiber into the protective sleeve.

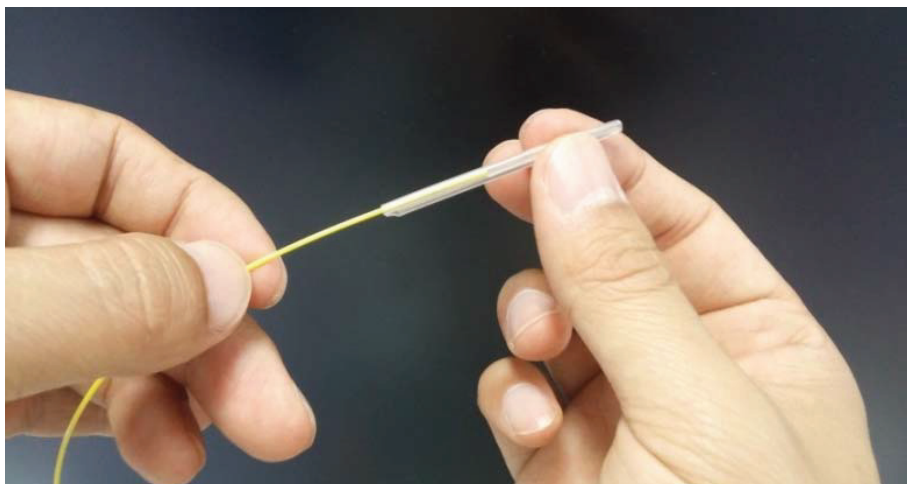

## 4.5 Fiber stripping

Automatic stripper of KF4A automatically performs accurate stripping with single fiber. This thermal stripper does not incur cracks on stripped fiber with superb tensile force. Stripping length of the fiber can be up to 28.0mm. To keep the equipment's optimal performance, thoroughly understanding and memorizing the instructions is extremely important for proper use.

Also, wipe the fiber clean with soft cloth or cotton moistened with alcohol.



Be careful not to soak this equipment in any kind of liquid.



Keep it clean all the time as it is vulnerable to humidity and dust.

Keep and use it at room temperature as deformation can be happened due to high temperatures.

Be careful to use the product as a breakdown can be happened due to vibration and shock.

When cleaning the product, do not use any organic solvent such as acetone other than alcohol on any of the rubber parts.

Fiber diameter	125 $\mu$ m
Cable diameter	250 $\mu$ m, 900 $\mu$ m
Cleaved length	Max 28.0 mm
Heating time	0 ~ 15 sec
Temperature range	60 °C ~ 150 °C
Tensile force after stripping	4kgf



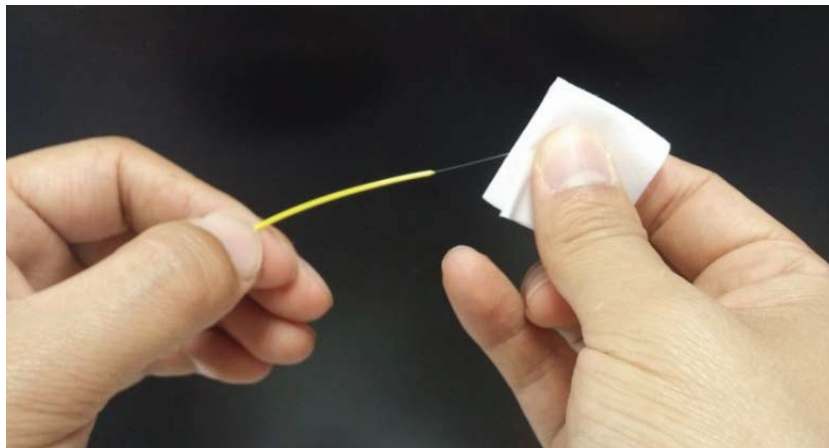

⚠ Use ethyl alcohol with a purity level of 96% or higher.

- i. Heater warms up. Make preparations by opening up the heater cover and slide cover.
- ii. Install fiber to be stripped on the holder as in the figure. The minimum stripping length is 18mm.
- iii. Place the holder with fiber on the holder base and close the cover.
- iv. When the heater cover is closed, the fiber heats up for the preset time period and the slider moves to the left to strip the fiber.
- v. When stripping is completed, open the slide cover and remove the holder. Opening up the heater cover will call back the slider automatically and get ready for the next stripping.
- vi. For the next procedure, remove the stripped sheath residue from the heater and blade parts using a soft brush, etc.  
Handle the blade part with care because it is easy to be contaminated and deformed.

## 4.5.1 Maintenance

### (1) Blade replacement and adjustment

- i. Remove the blade by unscrewing the bolt as shown in the figure when its fails stripping. Removal should be done after moving the slider and it stays to the left position.

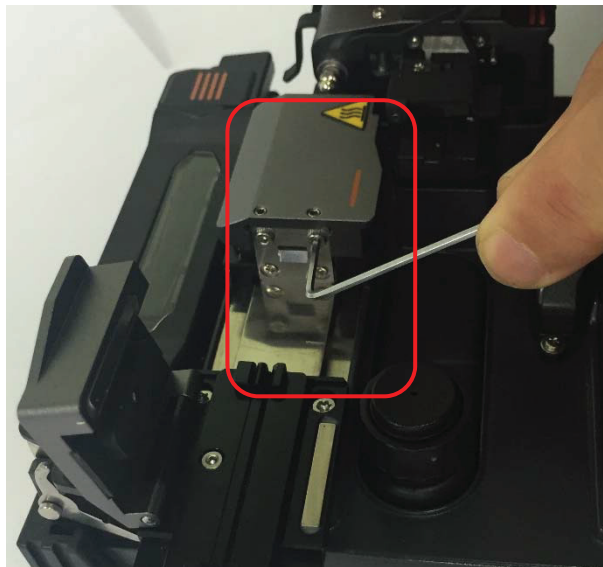

- ii. Assemble a new blade in reverse order of the disassembly process. (composed as 1 pair of each piece both at the top and the bottom)  
Setting and stripping can be done properly with no on the both top and bottom.

### (2) Product handling and storage

- i. As the main parts (blade, heater etc.) are closely related to the product's life, be careful with its use, during transportation and storage.
- ii. Do not apply excessive force or shock when handling the product.
- iii. Keep the main parts clean at all times of use by using a brush.
- iv. Maintain the product clean at all times.

## 4.6 Fiber cleaning

The alcohol dispenser of KF4A releases a fixed cleaning agent for fiber cleaning.

- ⚠ Be careful not to soak this equipment in any amount of liquid. Keep it clean at all times as it is vulnerable to humidity and dust. Keep and use it at room temperature as it can become deformed due to high temperature.
- Be careful when using this product as it may break down due to vibration and shock. When cleaning the product, do not use any organic solvent such as acetone other than alcohol on any of the rubber parts.

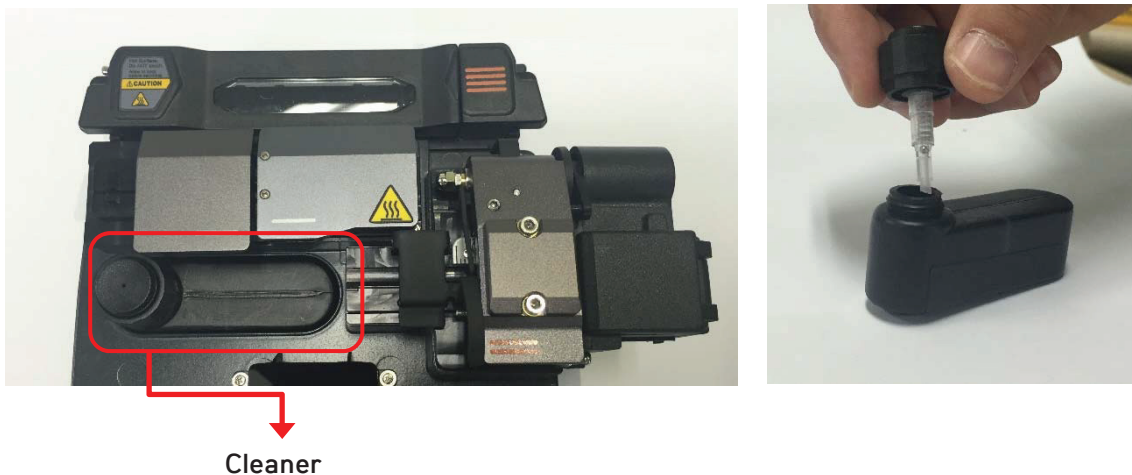

- i. When cleaning, arc the cleaning agent by pressing 2~3 times with cleaning cotton swab. Arc the cleaning agent while covering the entire outlet with cotton to prevent it from spraying outwards.
- ii. When the cleaning agent is no-longer pumped, refill it by opening the cap.
- iii. Use MCC-POC03M as the exclusive cleaning agent.

## 4.7 Fiber cleaving

The automatic cleaver of KF4A cleaves by 90 degree angle cleaving with a single fiber. Stripping should be in a proper condition.

Fiber alignment in the holder must be in an appropriate condition.

The blade condition and height of the blade at the cleaver should be maintained in a proper manner.

- i. Open the cover and set the holder with the fiber on the holder base and align the stripped fiber straight over the blade, Check the alignment of the fiber.



<Φ250 type>

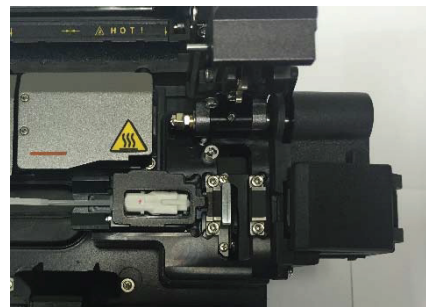

<Connector type>

- ii. Cleave the fiber by pressing the cover.

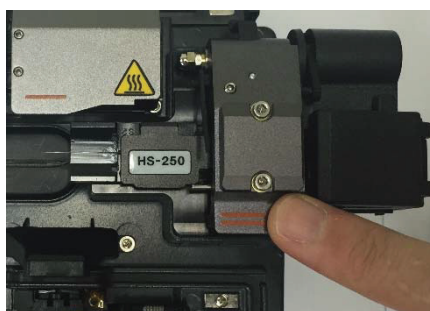

<Φ250 type>



<Connector type>

- iii. Check the cleaved the end face of the fiber with the cover open.



< $\Phi 250$  type>



<Connector type>

- iv. Remove the cleaved fiber and holder.  
Be careful not to leave any dust or foreign substance on the fiber.  
Cleaved chips are collected by an automatic chip collector.

 For the detailed use of cleaver, refer to the instructions for blade use.

#### 4.7.1 Blade adjustment and replacement

- 1~16 channels are shown on the blade. (Cleaving locations).
- When the cleaving is not normally done, wash the blade's edge and rubber pad both at the top and the bottom with cotton swab moistened with alcohol. (Do not use acetone or solvent when cleaning the rubber pad.)
- If cleaving continuously fails, change the channel or replace the blade as the life of the blade has ended.



## 4.7.2 How to change blade channel (cleaving locations)

- i. Remove the cleaver from KF4A main body using a hex wrench as in the figure.



- ii. Then remove the chip box using a hex wrench as in the figure below.



- iii. Open the cover; with the slider advanced, then unscrew the set screw using a wrench as in the figure.

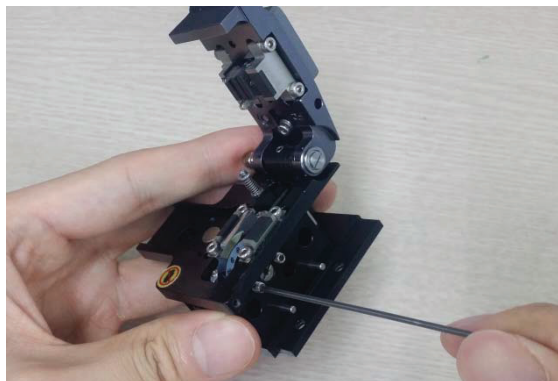

- iv. Turn the blade counterclockwise by 1 mark with a cotton swab. Assembly is done in reverse order.

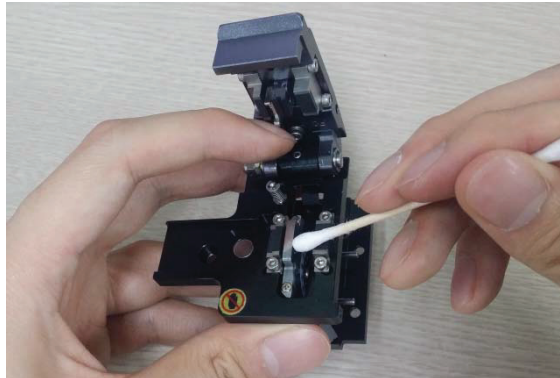

### 4.7.3 Blade replacement

- i. With cleaver removed from KF4A, unscrew the set screw using a wrench as in the figure.

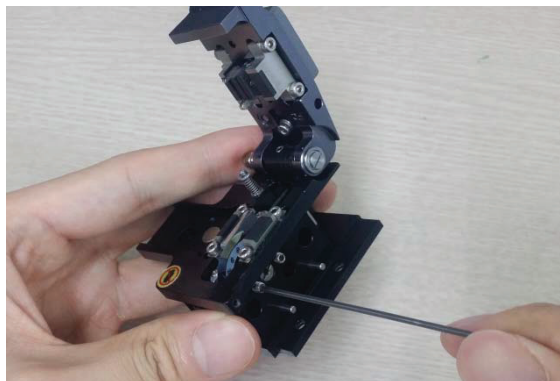

- ii. Insert a wrench from the bottom of the cleaver as in the figure and properly unscrew the set screw from the slider. Slider should be rear warded.



- iii. Turn the wrench bolt; put it in Cam Pin and then remove it from the slider by pulling with a tweezers, etc.

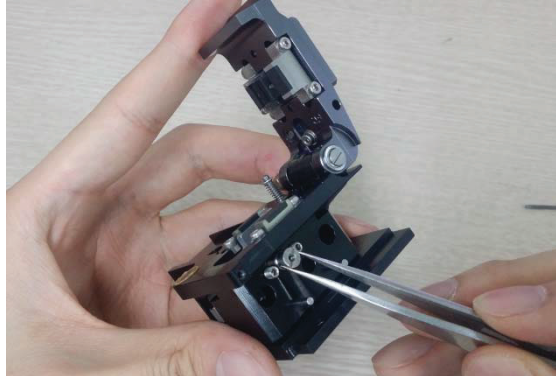

- iv. Pay special attention in order to prevent blade damage while replacing it. Assembly is done in reverse order of disassemble and the set screw should be firmly tightened.

#### 4.7.4 Blade height adjustment

- i. Insert a wrench in the bottom of cleaver as in the figure and properly unscrew the set screw of slider. Slider should be back warded.



- ii. Turn the Cam Pin with flat - headed screwdriver to adjust the blade's height.  
Turning clockwise : Blade going up  
Turning counterclockwise : Blade is going down

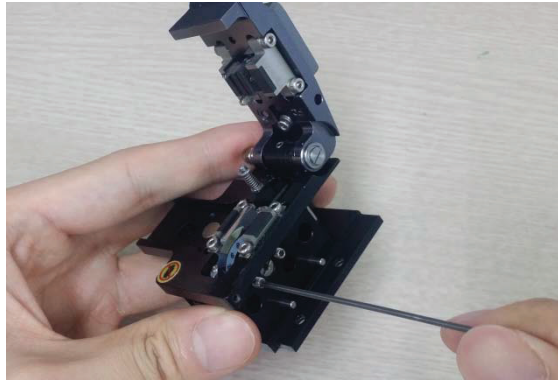

When the blade is adjusted to the proper height, tighten the set screw of slide. The height adjustment of the blade is closely related to cleaving quality. Make sure you perform height adjustment with BHS-01, sold separately. Please contact customer service for the information and availability of BHS-01.

## 4.8 KF4A Sleeve-Heater

The sleeve heater of KF4A reinforces spliced point of the single fiber. The quality of fusion splicing on the fiber should be good. Fiber that sleeve tube is inserted to heater should be properly aligned and installed. Heater cover should be closed while heater is on.

Cable diameter	$\Phi 250\mu\text{m}$ , $\Phi 900\mu\text{m}$ , $\Phi 2.0\text{mm} \sim \Phi 3.0\text{mm}$
Sleeve length	standard 32mm
Sleeving time	20~35 sec
Temperature range	130°C ~ 200 °C

- i. Open up the heater cover to start.



- ii. Place the sleeve tube on the spliced point. Make sure center of the sleeve



tube covers the spliced point. Load the fiber into the heater.  
For the fusion splice on connectors, load it into the right end of the heater  
and press the sleeve tube into the heater as tight as possible.



- iii. After settling the fiber, turn on the heater by pressing . (Heating time 20sec)



- iv. Remove the sleeve protected fiber by opening the cover when the cooling is completed.

 The better positioning of the fibers will shorten heating time

## 4.9 Splice procedure

The status and cleaved quality of the fiber can be monitored by using an image processing system by Swift KF4A. For better splice result, however, visual inspection is required also.

In auto mode, the splice procedure begins automatically as the wind cover is closed.

- i. Fibers installed on the splicer advance toward each other and stop. The fibers align once cleaning arc is done. After that, the splicer checks cutting-the cleaved angle of each fiber, the shape of the end faces, contaminations and so on. When the measured cleaved angle is bigger than the preset value or damage is detected on fiber, error message is displayed on the screen. And splice procedure stops as well. Even if there is no error message displayed, visual inspection on the monitor screen is always recommended.
- ii. Fibers are aligned cladding to cladding after inspection. Deviation on clad axis can be displayed on screen.
- iii. After alignment completes, arcing is conducted to splice fibers.
- iv. After splicing is completed, the estimated value of loss is displayed on the screen. The estimated value of splice loss is subject to various factors related to error. These factors related to an error affect the estimation and calculation of estimated loss value as well. Calculation of estimated loss is based on factors such as MFD. When estimated loss value exceeds the preset value and error message is displayed on the screen. The error message is also displayed when the spliced fibers are too thick or thin or when bubbles are generated on the spliced point. If the splice result shown on the screen is not considered good enough, it is recommended to conduct splicing again
- v. The splice result is saved as follows.

When splice completes, splice result is automatically saved.

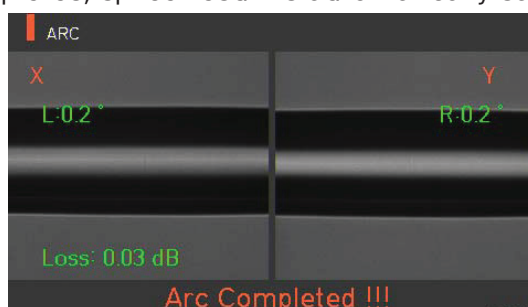

## 4.10 Removing the spliced fiber

- i. Open the cover of the sleeve heater.
- ii. Open the wind cover.
- iii. Hold the fiber on the left and open the clamp on the left.
- iv. Open the fiber clamp on the right.
- v. Hold both sides of spliced fiber and separate the fiber from Swift KF4A with care.

## 4.11 Heating protection sleeve

- i. Move spliced point to the center of the protecting sleeve. Place the protected pin in the sleeve with face down.
- ii. Place the protecting sleeve at the center of sleeve heater.
- iii. Hold and put down the both fibers as shown in the figure then the heater cover will automatically close.
- iv. Heating starts by pressing .
- v. LED is turned off when heating is completed.
- vi. Open the heater cover and take out the fiber. Do not touch the protecting sleeve or heater at any point during or right after heating.
- vii. Conduct a final inspection on whether there are bubbles, fragments or any dust on the sleeve.





## 4.12 Use of Work Belt

The work belt of Swift KF4A is a type of auxiliary equipment that combines with its main body to facilitate working at a manhole, utility pole, etc.

### 4.12.4 Use of Work Belt



Work belt components



## V. Maintenance of splice quality

---

### 5.1 Cleaning and Inspection before splice

#### 5.1.1 V-Groove cleaning

When the inside of V-Groove is contaminated, splice quality may deteriorate. Thus, it is important to regularly inspect and frequently clean the V-Groove as follows.

- i. Open the wind cover.
- ii. Clean the V-Groove using a cotton swab moisten by alcohol and any proper cleaning agents. Remove the remaining alcohol from the V-Groove using a clean and lint free dry cotton swab.
- iii. When a foreign substance is not removed with cotton swab, clean it with the tip of a cleaved fiber and then repeat the step above.

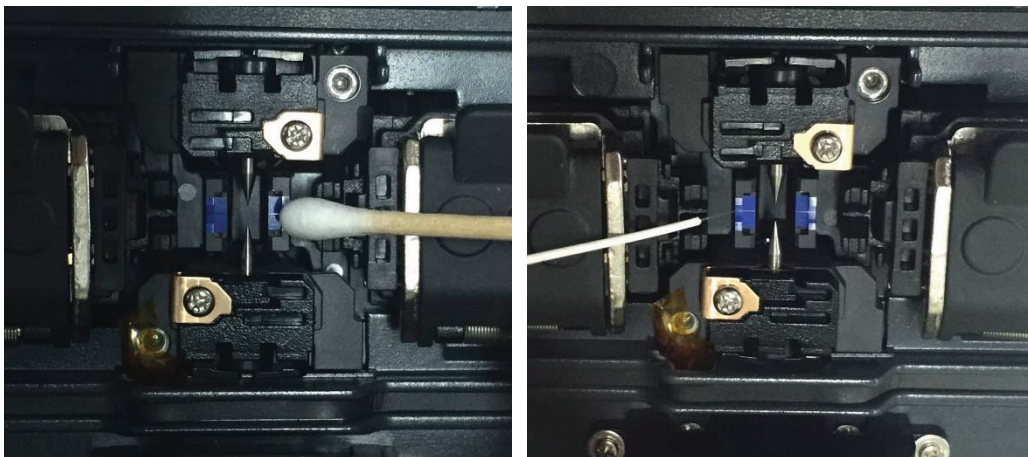

## 5.1.2 Pusher Block cleaning

Pusher Block contamination incurs poor splice quality due to irregular pressure apply to the fibers Thus, it is important to frequently inspect and regularly clean it.

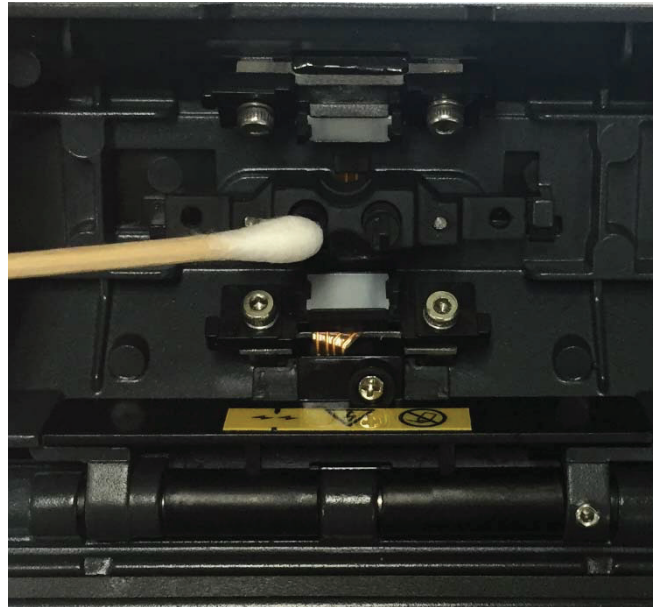

## 5.1.3 Cleaver cleaning

If the cleaver's blade and rubber pads are contaminated, the cleaving quality may deteriorate. In turn, the splice loss rate can be consequently increased. Thus, clean the cleaver blade and rubber pad frequently using a cotton swab moisten by alcohol. This is critical to keep the cleaved quality of the-fiber. (Do not use acetone or solvent when cleaning the rubber pad.)

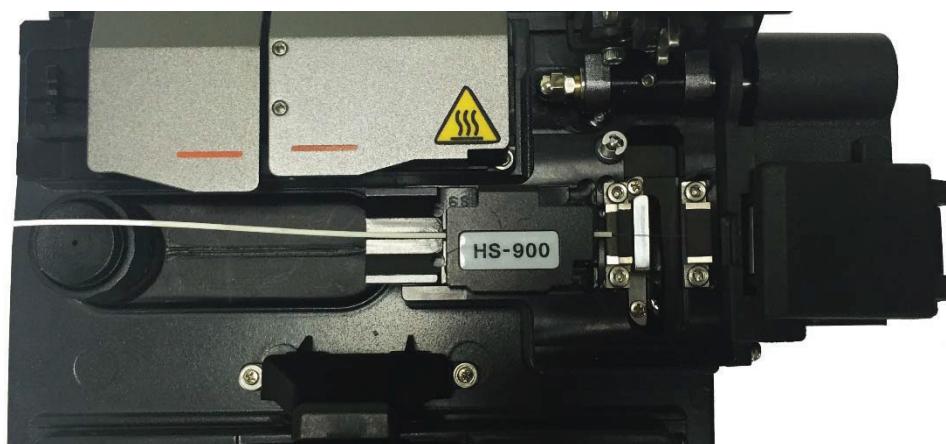

## 5.2 Regular inspection and cleaning

To ensure splicing quality, regular inspection and cleaning is required.

### 5.2.1 Object lens cleaning

Contamination on object lens' surface disturbs the identification of fiber core location and consequently incurs high splice loss. Thus, 2 object lenses should be kept clean at all times. If accumulated dust stays for a prolonged period, it may be difficult to remove. Therefore, clean the lens frequently as follows.

- i. Turn the power off before cleaning the object lens.
- ii. Separate the Electrodes.
- iii. Clean it using a soft cotton swab moisten with alcohol in circular motion from the center as in the figure below. Dry out alcohol remaining on object lens' surface using a clean, lint free dry cotton swab

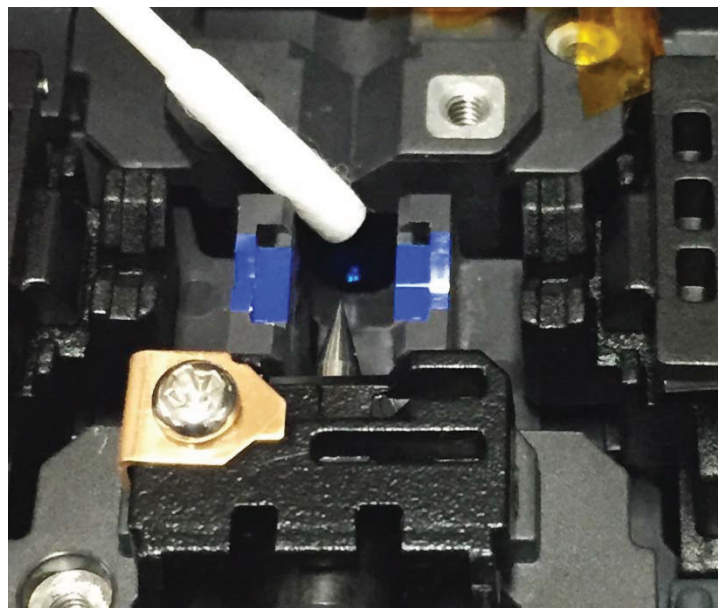

- iv. Surface of object lens should be clean without any line or stain.
- v. Reassemble the Electrodes.
- vi. Turn the power on; check whether there is any line or stain on the monitor and; conduct a self-diagnosis.

## 5.2.2 Electrodes replacement

It is recommended to replace the electrodes after using appx 3,000 times. If the number of arc exceeds the replacing cycle, a message for electrodes replacement is displayed on the screen. Without electrodes replaced splice loss increases and the tensile force at the splicing point weakens.

- i. Turn the power off when replacing the electrodes.
- ii. Open the wind cover and unscrew the clamp screw of the electrodes block.

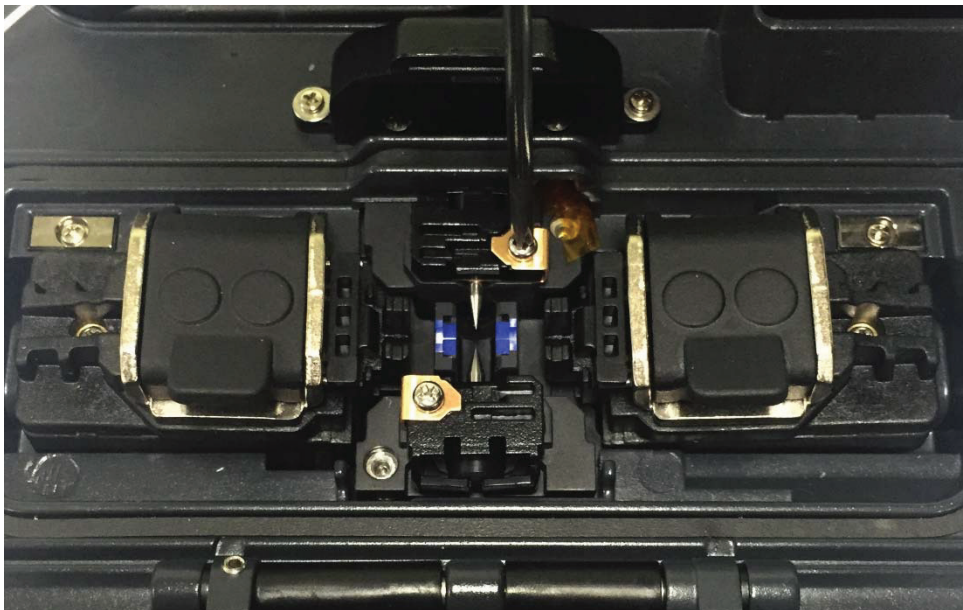

- iii. Remove the electrodes block and the electrodes.

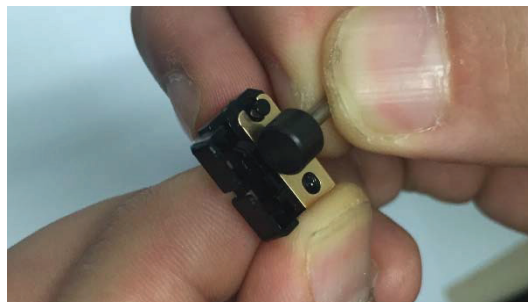

- iv. Clean the electrodes carefully by using a soft cotton swab moisten by alcohol, then install it.
- v. Turn the power on and conduct electrodes stabilization process in the menu.

## VI. Menu

The main menu has 10 submenus. Press  to load main menu. The 10 submenus can be selected by using     and  or by directly pressing the screen. The main menu screen is as follows.

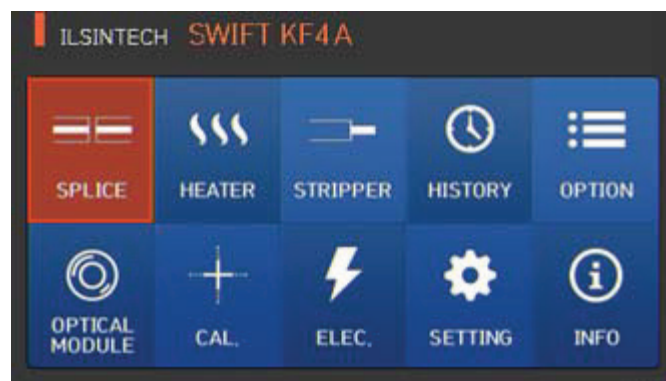

- Splicing
  - ✓ Delete: Deletes splice mode.
  - ✓ Replace: Selects and replaces a certain splice mode within the database.
  - ✓ Add: Selects and adds a certain splice mode within the database.
  - ✓ Edit: Edits set values of splice mode.
  - ✓ Select: Selects a splice mode to run.
  - ✓ Close: Closes the menu window.
- Heater
  - ✓ Delete: Deletes heater mode.
  - ✓ Replace: Selects and replaces a certain heater mode within the database.
  - ✓ Add: Selects and adds a certain heater mode within the database.
  - ✓ Edit: Edits set values of in the heater mode.
  - ✓ Select: Selects a heater mode to run.
  - ✓ Close: Closes menu window.

- Stripping
  - ✓ Delete: Deletes stripping mode.
  - ✓ Replace: Selects and replaces a certain stripping mode within the database.
  - ✓ Add: Selects and adds a certain stripping mode within the database.
  - ✓ Edit: Edits set values of for the stripping mode.
  
- Splice result
  - ✓ Splice result display: Displays splice result and image.
  - ✓ Delete splice result: Deletes all data.
  
- Option
  - ✓ Splice operation initial setting: Auto, Pause, Auto heater
  - ✓ Menu lock: Menu lock setting
  - ✓ Password: Password setting upon locking
  
- Optical module
  - ✓ Optical Power Meter: Checks up optical power meter information
  - ✓ V.F.L.: Activate visual fault locator.
  
- Calibration
  - ✓ Arc calibration: Adjust arc calibration intensity.
  - ✓ Diagnostic test: Diagnoses equipment state.
  - ✓ Motor operation: Operates motor manually.
  - ✓ Motor calibration: Initializes motor's speed and location.
  
- Electrodes
  - ✓ Electrodes stabilizing: Conducts electrodes stabilizing.
  - ✓ Electrodes caution: Sets the number of uses to inform when to replace the electrodes.
  - ✓ Electrodes replacement: Explains how to replace the electrodes.
  - ✓ Number of using electrodes: Displays the electrodes use count.

- Setting

- ✓ Language: Selects a language.
- ✓ Time: Sets the present time.
- ✓ Sleep: Sets sleep mode.
- ✓ Sound: Adjusts intensity of the buzzer sound.
- ✓ LCD brightness: Adjusts the brightness of the screen.

- Information

- ✓ Maintenance: Displays maintenance schedule.
- ✓ Sensor: Indicates temperature, pressure.
- ✓ Version: Shows the current version of product.
- ✓ Help: Consists of the following.
  - Name of each part
  - Cleaning and Inspection
  - Cautions
  - Contact IIsintech



## Popup Menu

The purpose of the popup menu is to facilitate easy and quick access to the splice mode and heater mode. User can access the popup menu in various ways.

### [Displaying popup menu]

- i. Splice popup menu can be displayed the current splice mode by pressing



on initial screen.

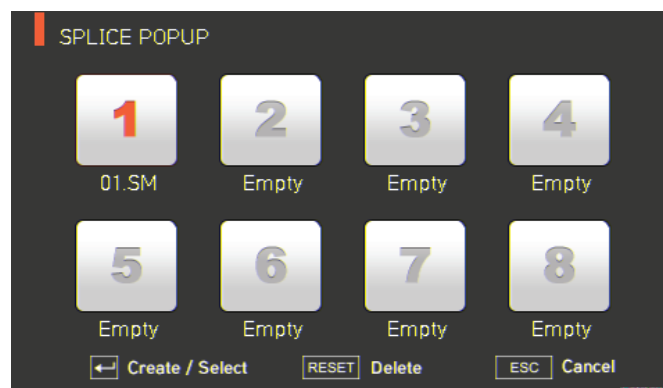

- ii. Heater popup menu can be displayed the current heater mode by pressing



on initial screen.



- iii. Stripper popup menu can be displayed the current stripping mode by pressing  on initial screen.

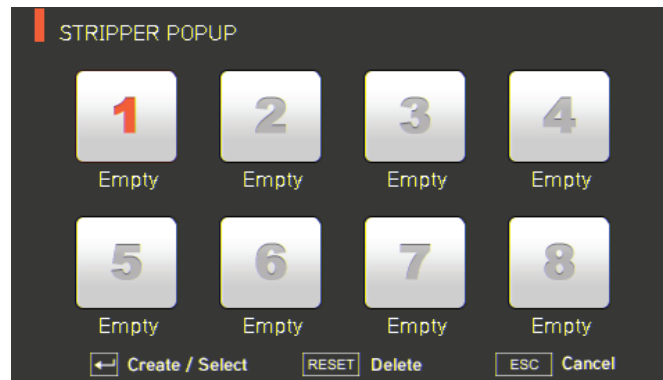



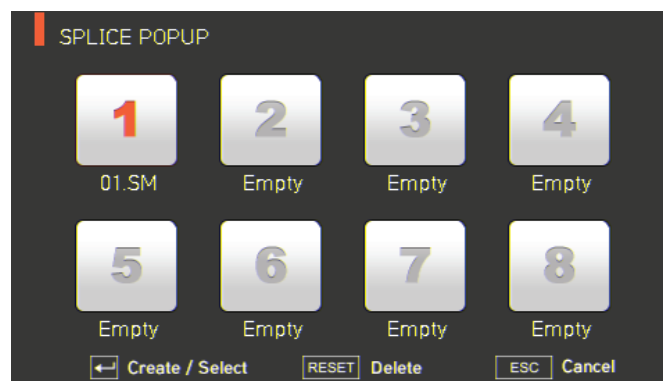

## [Splice popup menu]

- Adding splice mode

- i. Display splice popup menu by pressing  on initial screen.



- ii. Select an empty slot by pressing     and then press .



iii. Select a splice mode to add up to the empty slot.

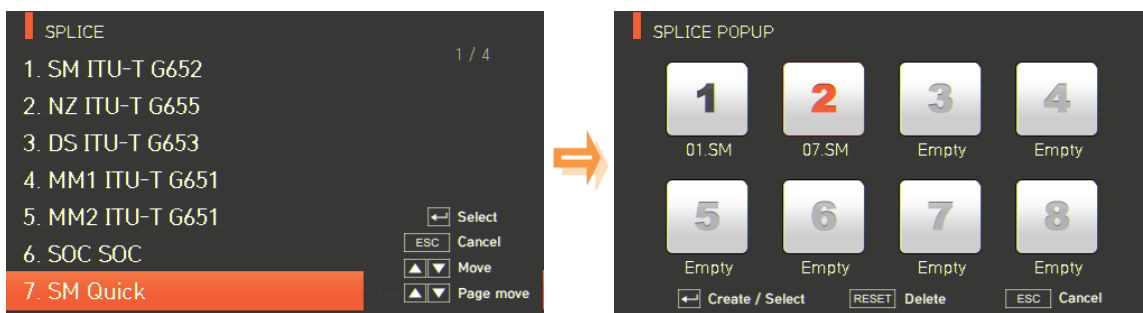

- Deleting splice mode

i. Select a mode to be deleted.

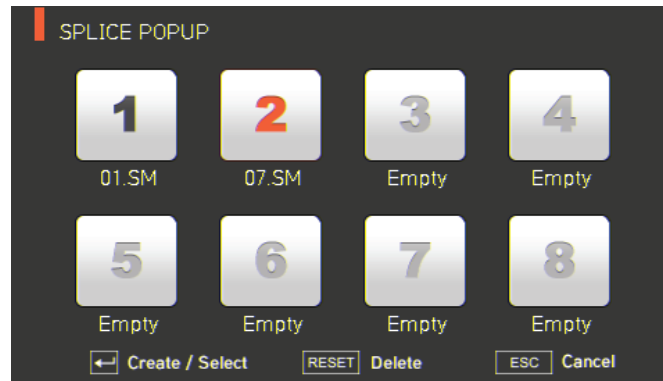

ii. Delete it by pressing







## [Heater popup menu]

- Adding heater mode

- Display heater popup menu by pressing  on initial screen.



- Select an empty slot by pressing     and then press .

- Select a heater mode to add up to the empty slot.

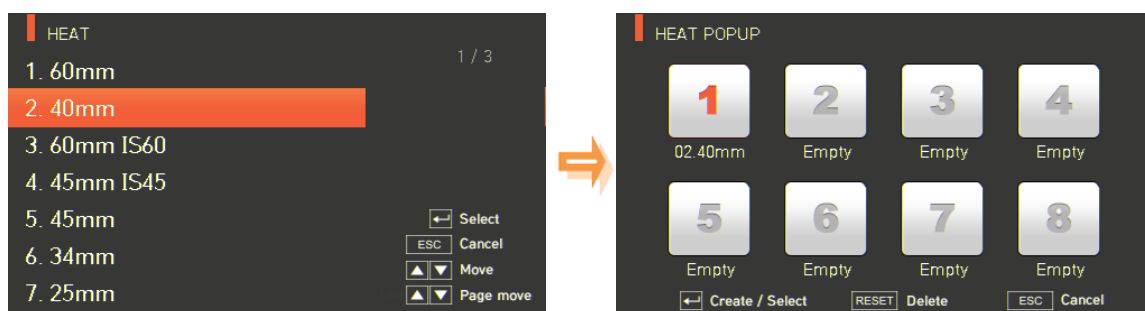

- Deleting heater mode

- Select a mode to be deleted.

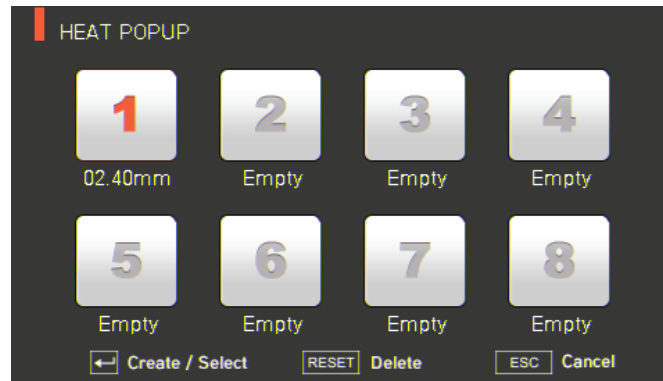

- Delete it by pressing .





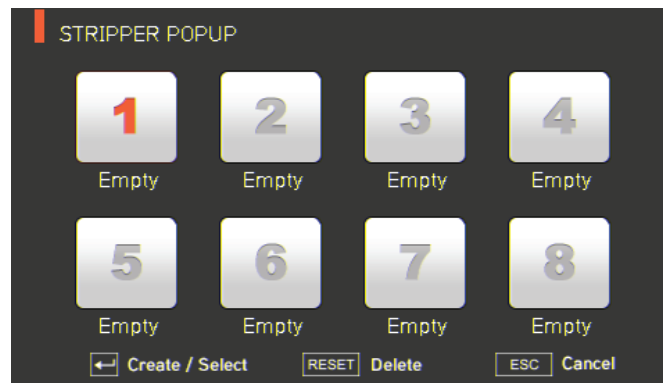

## [Stripping popup menu]

- Adding stripping mode

iii. Display stripping popup menu by pressing  on initial screen.



ii. Select an empty slot by pressing     and then press .

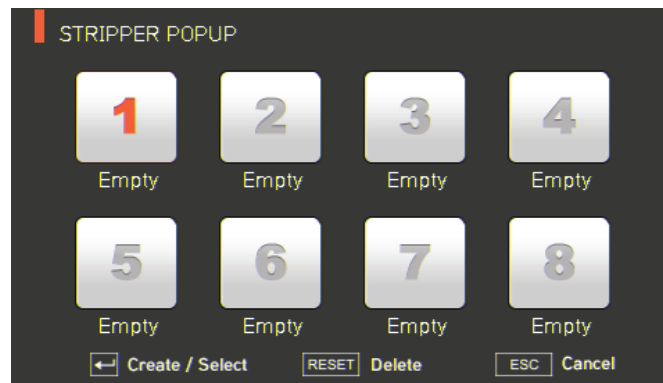

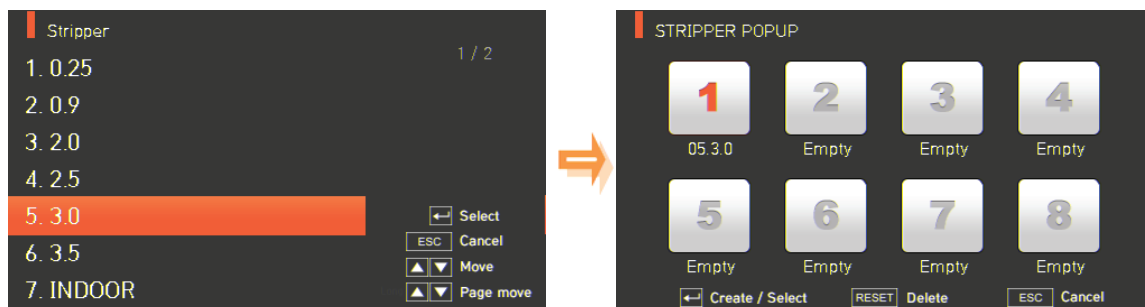

iv. Select a stripping mode to add up to the empty slot.

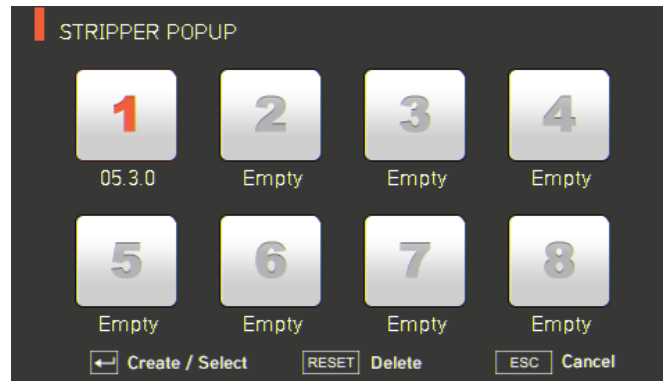

- Deleting stripping mode

ii. Select a mode to be deleted.



ii. Delete it by pressing .





## 6.1 Splice

To display splice mode, press and select "Splice" menu with button. It displays a screen to select splice mode as follows. The screen has a list of splice modes to facilitate a user's easy selection and use of splice mode. In addition, splice mode can be expanded and saved up to 300 modes. These splice modes are classified into general mode and user-defined mode.

- General splice mode: No. 1~27
- User-defined splice mode: No. 28~300



### [ Splice modes summary]

Splice mode	Description
SM	For basic SM fiber. MFD of single mode fiber is about 9~10 $\mu\text{m}$ at 1310nm wavelength.
NZ	For NZDS fiber. MFD of NZDS fiber is about 9~10 $\mu\text{m}$ at 1550nm wavelength. WDM fiber can also be spliced on this mode.
DS	For DS fiber. MFD of DS fiber is about 7~9 $\mu\text{m}$ at 1550nm wavelength.
MM	For MM fiber. Core diameter of MM fiber is about 50~62.5 $\mu\text{m}$ .
Other	Other splice modes are saved on the database of Swift KF4A. New splice modes are currently being updated. Therefore, we recommend that users keep upgrading the equipment regularly by contacting Ilsintech.

### 6.1.1 Deletion

First, select a splice mode by pressing . And then press and the selected mode is deleted. General modes no. 1~27 are unable to be deleted.

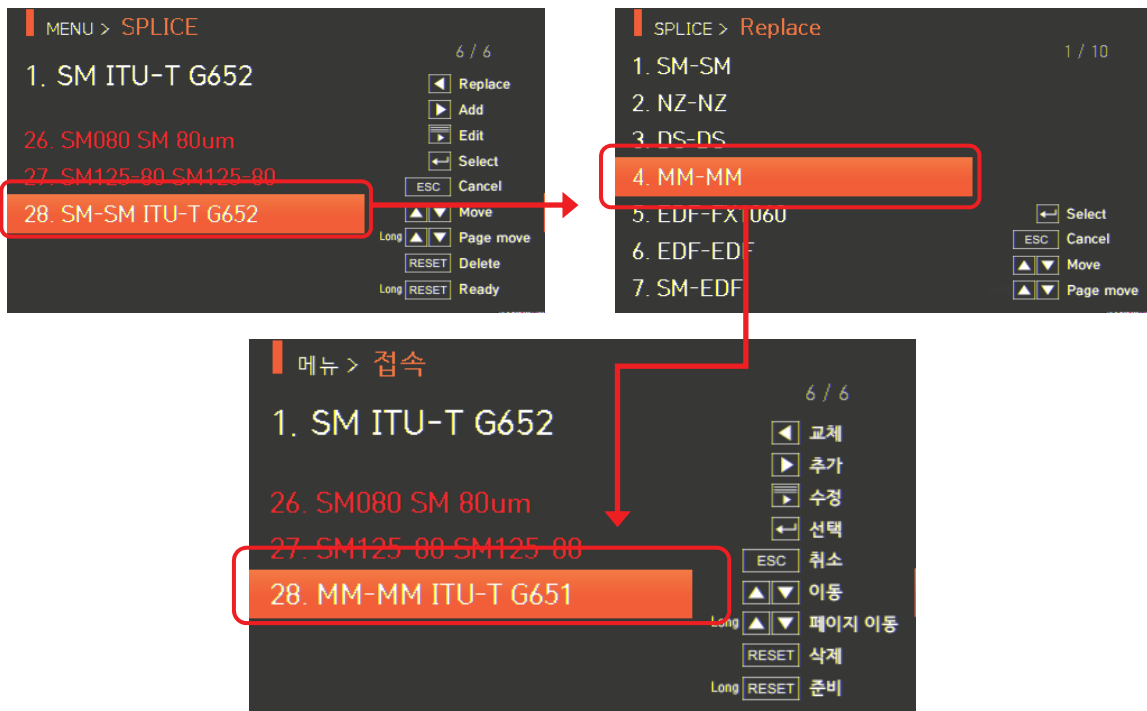

### 6.1.2 Replacement

Select a splice mode to replace and press , and splice modes saved on the database are displayed on the screen. Select a splice mode to replace and press , and the mode is replaced with the new mode.



General modes no. 1~27 are unable to be replaced.

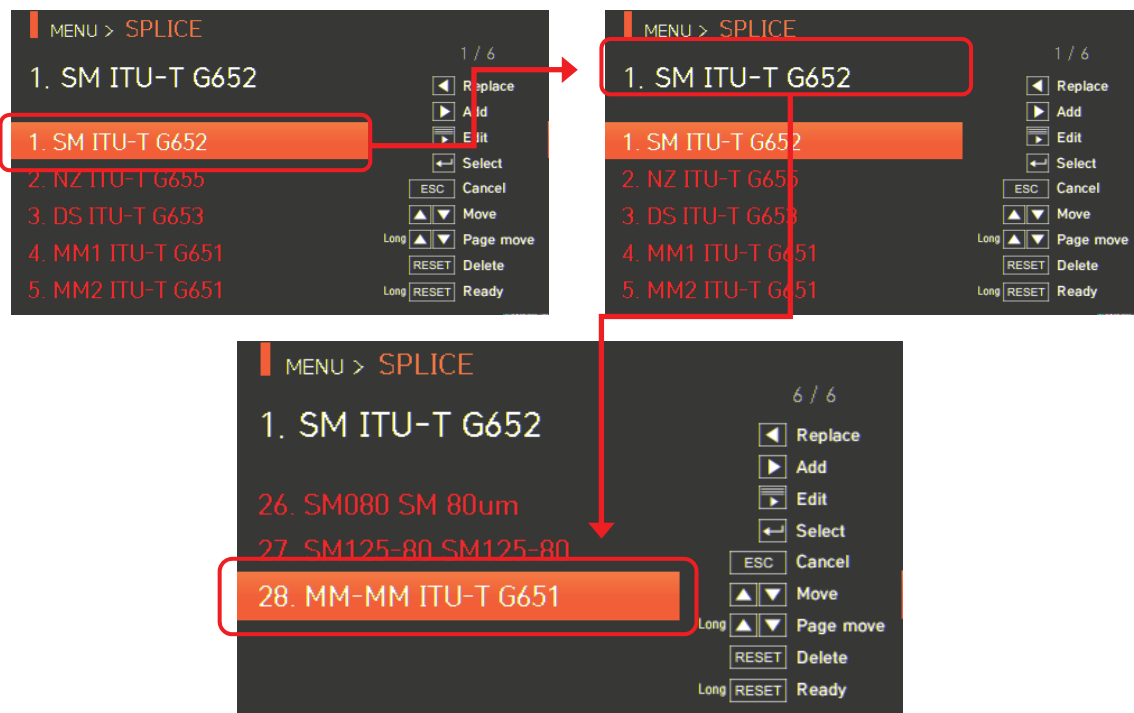

### 6.1.3 Addition

Press  and splice modes saved on the database are displayed on the screen. Select a splice mode to add and press , and the mode is added. The newly added mode is located on the last number.



Additions are unable to be made on general modes no. 1~27.

## 6.1.4 Edition

Select a splice mode to edit with  and press  then different set values of the selected splice mode are displayed. Press a set value and change it into the proper one.

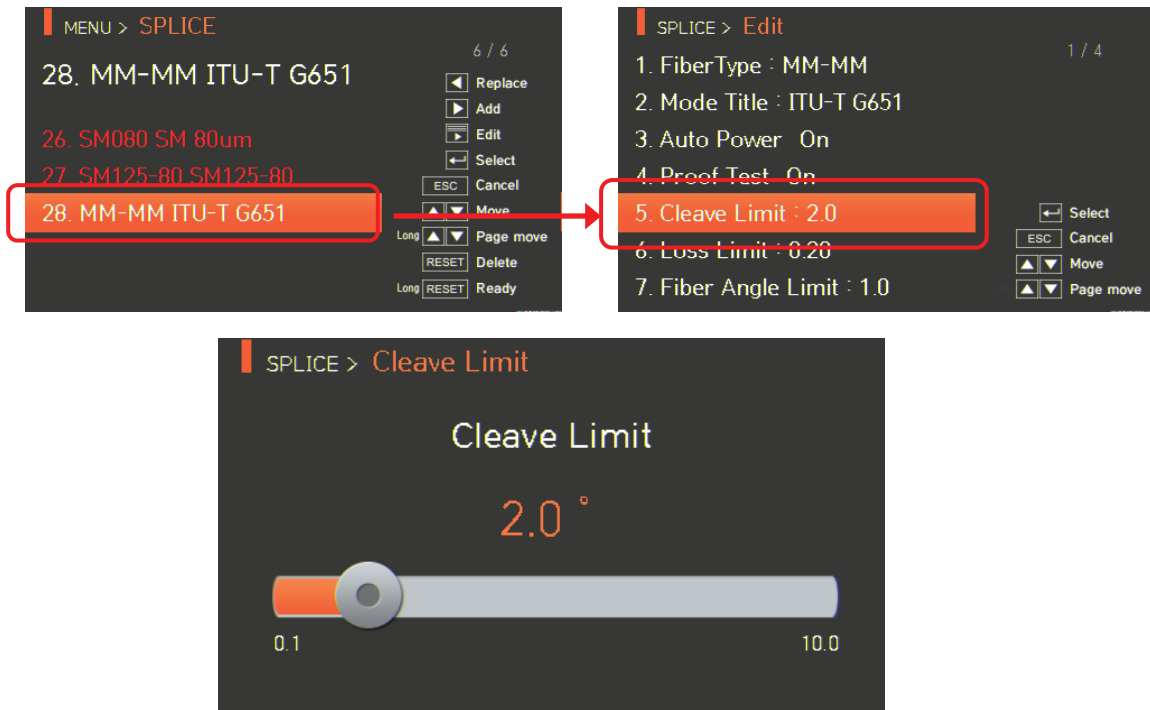

**[Set values editable within mode]**

Set value	Description	General mode	User mode
Fiber Type	Displays the list of splice mode that is saved on the splicer data to facilitate the selection of a proper mode for use. Among splice modes saved on the database, it copies a similar splice mode to use an editing function.	Editable	Editable
Mode Title	Mode title 1 is for indicating splice mode within 11 characters at a maximum.		
Auto Power	The closer fibers are aligned to the core center with a fewer number of errors, the quicker and better the arcing is done.	Uneditab le	
Proof Test	Conducts tensile force test after splice.		
Cleaved Limit	Sets the cleaved angle's error limit.	Editable	
	When either of the cleaving angles on both fibers are outside the limit., an error message is displayed.		
Loss Limit	Sets the estimated loss value's error limit.		
	When estimated loss is higher than the limit, error message is displayed.		
Fiber Angle Limit	When the bending of 2 spliced fibers exceeds the set limit, an error message is displayed.	Uneditab le	
Cleaning Power	A short arc cleaning is conducted to remove fine dust on the fiber surface upon initial stage of fiber alignment. It sets the intensity of the cleaning arc.	Editable	
Cleaning Time	It sets the time for the cleaning arc.	Editable	
Gap	Upon final alignment, it sets the clearance of the cross section between both fibers.		

Gap set Pos	<p>It sets location of fiber spliced at the center of arc.</p> <p>When MFD of both fibers differs, do the sealing procedure by melting the smaller MFD fiber more than the bigger MFD fiber. To heat the smaller MFD fiber more, splice loss can be lowered by moving the clearance location toward the bigger MFD fiber at the center of arc.</p>	Uneditab le	
Prefuse Power	<p>It sets initial arc amount from the beginning of arc before the fiber is advanced. If the value of initial arc amount is too low, the angle of the fiber cross section is poor and consequently, an offset can be incurred on the axis if it is too high, the fiber can made round or burnt too much and, consequently, the splice loss value can be big.</p>		
Prefuse time	<p>It sets the initial time from the beginning of the arc before the fiber advance. If [Prefuse time] is long, it means the same that [initial arc amount] gets big.</p>		
Overlap	<p>It sets the duplication of the fiber <del>an</del> for the fiber advance amount.</p> <p>If [Prefuse Power] is weak or [Prefuse time] is short, set the [overlap] to somewhat small and if the arc amount is strong and the time is long, set it to somewhat big.</p>		
Arc1 Power	<p>Main arc can be adjusted by 2 levels. The first level of arc is [Arc1 Power] and the second is [Arc2 Power]. [Arc1 Power] is set in this area.</p>		
Arc1 Time	<p>It sets the time for [Arc1 Power].</p>		

Arc2 Power	[Arc2 Power] is the second level of arc. [Arc2 Power] is set in this area.		
Arc2 Time	<p>It sets the time for [Arc2 Power].</p> <p>It sets the time for [Arc2 Power]. [Arc time 2] is generally set as "OFF."</p> <p>It can set the arc time as a very long time period but when [Arc1 Time] and [Arc2 Time] exceed 30 seconds, the electrodes can be damaged.</p>		
Arc2 On - Time	<p>While [Arc2 Power] is on arc, you can set the arc amount as "ON" and "OFF" in turn.</p> <p>The time period for [Arc2 Power] being "On" is set in this area. For re-arc, set the arc time as "ON" at all times.</p>	Uneditab le	
Arc2 Off - Time	<p>It sets the time period for the arc of [Arc2 Power] when it is turned off.</p> <p>When [Arc2 Power] is occasionally stopped, re-arc can also be stopped. When re-arc is continuously required, set as to "OFF."</p>		Editable
Rearc Time	<p>It sets re-arc time.</p> <p>Within [splice mode edition], it automatically sets to arc the re-arc amount with the same intensity as that of [Arc2 Power].</p> <p>If [Arc2 Power] is set as ON/OFF, re-arc is automatically changed.</p>	Editable	
Taper Splice Off	When the fiber is made thin, the splice loss is sometimes increased. This pulling function is set to "OFF." The following 3 parameters decide the pulling shape.	Unedieta ble	

Taper Wait	It designates the time period from the last of the advanced fiber amount to the beginning of pulling.	
Taper Speed	It sets the fiber pulling speed.	
Taper Length	It sets the fiber pulling time.	
Offset	It is the sum of the initially measured splice loss value and the increased loss. When splicing a special fiber or other fibers, high loss may be incurred in spite of optimum arc conditions. To match the estimated splice loss and the actual splice loss, the minimum value of actual splice loss should be set.	Editable

### 6.1.5 Selection



Press  and the selected splice mode is saved on memory and it is used upon splicing.

### 6.1.6 Close

Press  and it goes back to the previous stage.



## 6.2 Heater

To display heater mode, press  and then select "Heater" from the menu with  button. It displays a screen to select the heater mode as follows. The selecting screen is equipped with various heater modes to facilitate the user's easy selection and use of the heater mode. In addition, heater mode can be expanded and saved for up to 100 modes. Heater mode no. 1~16 cannot be deleted or replaced either.

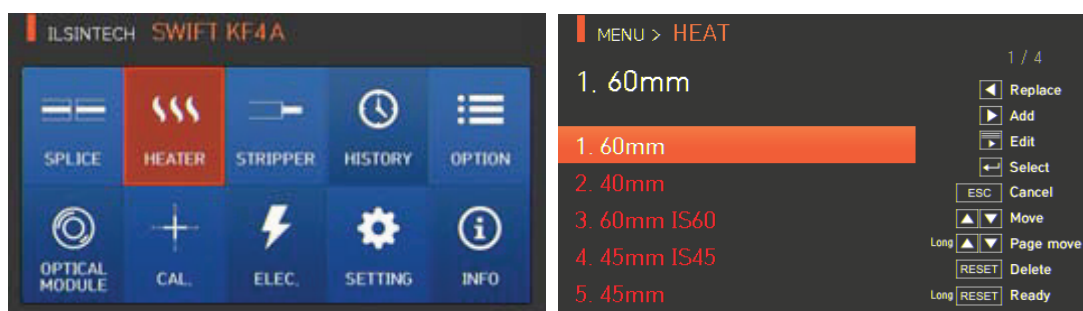

## [Outline of heater mode]

Set value	Description	Others
60mm	Standard 60mm micro sleeve	
40mm	Standard 40mm micro sleeve	
60mm IS-60	S-160 60mm micro sleeve	
45mm IS-45	S-145 45mm micro sleeve	
45mm	Standard 45mm micro sleeve	
34mm	Standard 34mm micro sleeve	
25mm	Standard 25mm micro sleeve	
20mm	Standard 20mm micro sleeve	
S09	45mm sleeve for 0.9mm cable	
S09-C	22mm sleeve for SOC(SC-0.9mm)	
S20	45mm sleeve for 2.0mm cable	
S30	32mm sleeve for SOC(SC-3.0mm)	
S30-C	32mm sleeve for SOC(SC-3.0mm)	
LC09/20-C	25mm sleeve for SOC(LC-0.9 , 2.0mm)	
ST09-C	28mm sleeve for SOC(ST-0.9mm)	
ST30-C	28mm sleeve for SOC(ST-3.0mm)	

## 6.2.1 Deletion

First, select a heater mode by pressing . And then press and the selected mode is deleted. General modes no. 1~16 cannot be deleted.

## 6.2.2 Replacement

Select a heater mode to replace and press and heater modes saved on the database are displayed on the screen. Select a heater mode to replace and press , and the mode is replaced with the new mode.

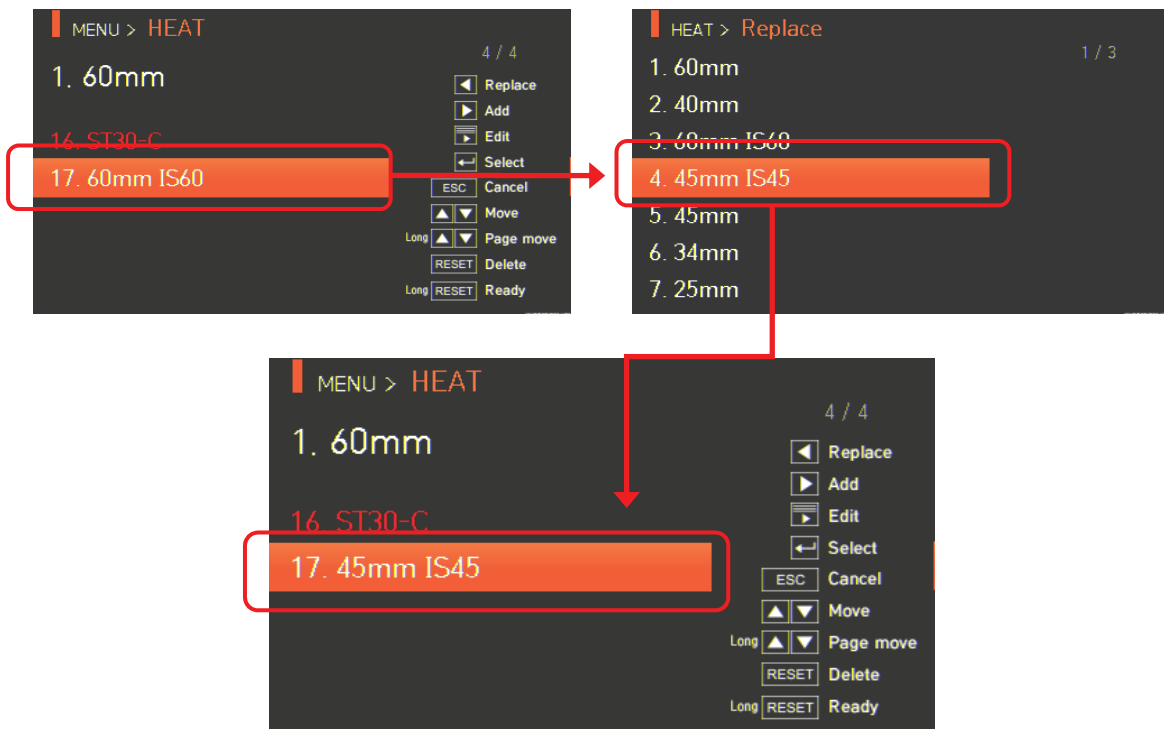

General modes no. 1~16 cannot be replaced.

### 6.2.3 Addition

Press  and heater modes saved on the database are displayed on the screen.

Select a heater mode to add and press , and the mode is added. The newly added mode is located on the last number.

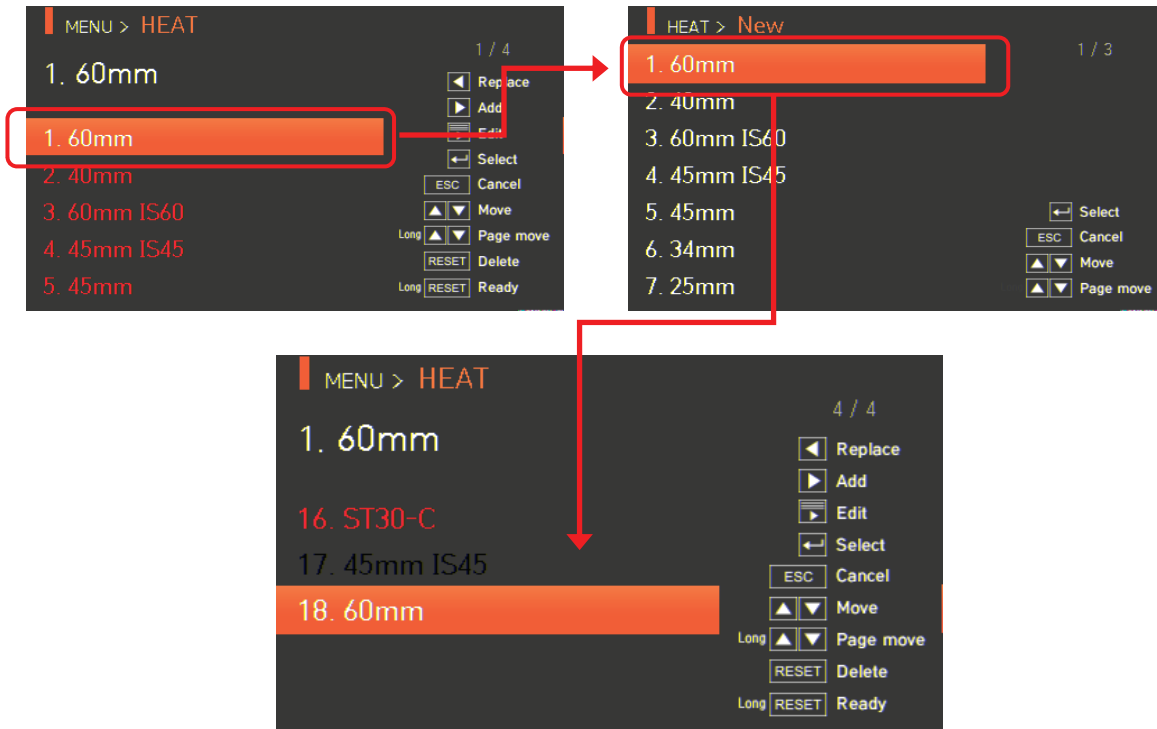

Addition cannot be made on general modes no. 1~16.

## 6.2.4 Edition

Select a heater mode to edit with and press and different set values of the selected heater mode are displayed. Press a set value and change it into the proper one.

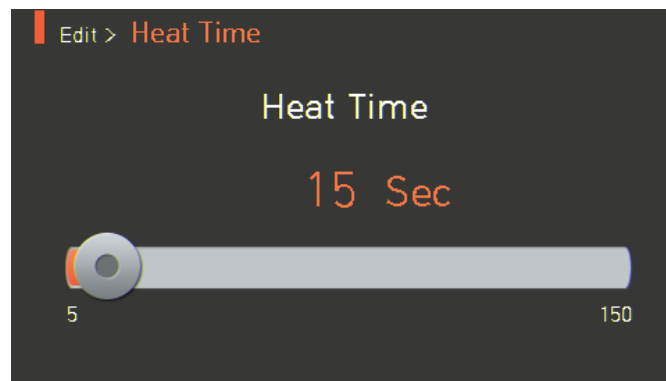



## 6.2.5 Selection

Press and the selected heater mode is saved on the memory and it is used upon operating the heater.

## 6.2.6 Close

Press and it goes back to the previous stage.

## 6.3 Stripping

To display the stripping mode, press  and then select “stripping” menu with  button. It displays a screen to select the stripping mode as follows. The selecting screen is equipped with various stripping modes to facilitate the user’s easy selection and use of the stripping mode. In addition, stripping mode can be expanded and saved for up to 100 modes. Stripping mode no. 1~7 cannot be deleted or replaced either.

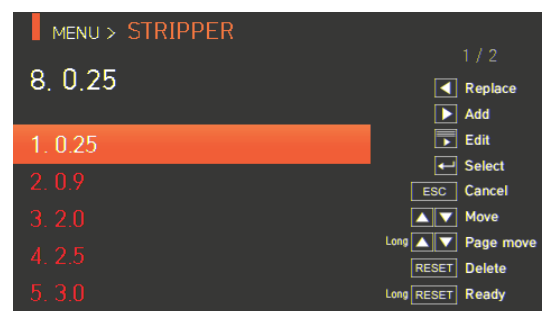
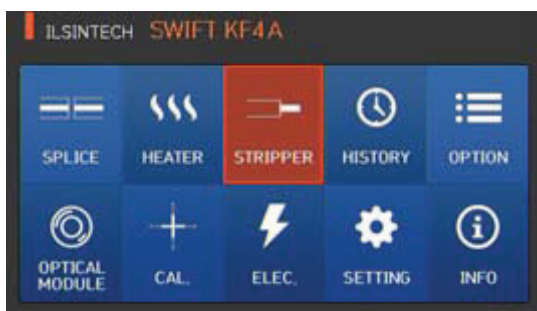

### [Outline of stripping mode]

Parameters	Description
Modes	<ul style="list-style-type: none"> <li>• Matching the sorts of fiber</li> <li>• All stripping lists are displayed.</li> <li>• The user may copy or chose program mode that is required or desired.</li> </ul>
Stripping time	<ul style="list-style-type: none"> <li>• As the stripping time can be selected between 0sec ~ 15.0sec, select the proper one for fiber sheath.</li> </ul>
Stripping temperature	<ul style="list-style-type: none"> <li>• Set stripping temperature.</li> </ul>

### 6.3.1 Deletion

First, select a stripping mode by pressing . And then press and the selected mode is deleted. General modes no. 1~7 cannot be deleted.

### 6.3.2 Replacement

Select a stripping mode to replace and press , and then the stripping modes saved on the database are displayed on the screen. Select a stripping mode to replace and press , and the mode is replaced with the new mode.



General modes no. 1~7 cannot be replaced.

### 6.3.3 Addition

Press  and stripping modes saved on the database are displayed on the screen.



Select a stripping mode to add and press , and the mode is added. The newly added mode is located by the last number.



Any additions cannot be made on general modes no. 1~7.



### 6.3.4 Edition

Select a splice mode to edit with  and press  and then different set values of the selected stripping mode are displayed. Press a set value and change it into the proper one.

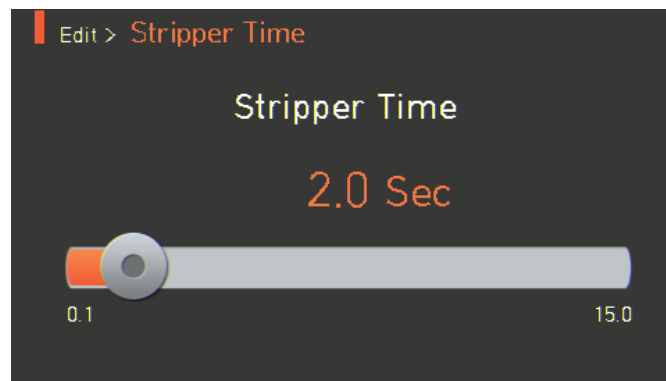
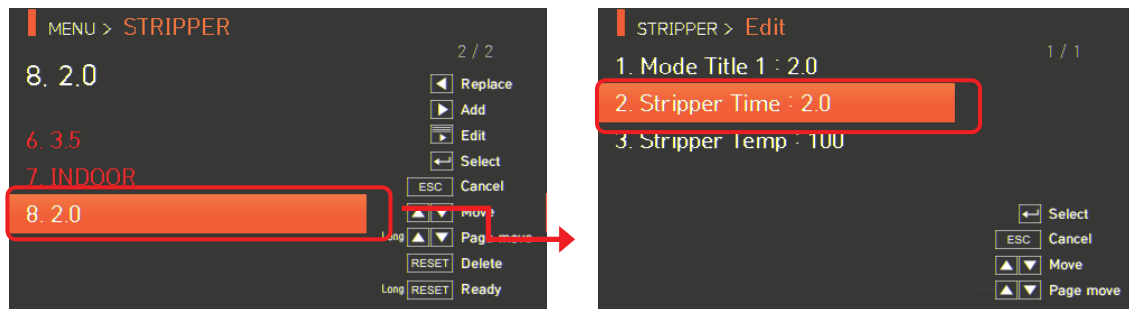



### 6.3.5 Selection

Press  and the selected stripping mode is saved on the memory and it is used when operating the heater.

### 6.3.6 Close

Press  and it goes back to the previous stage.

## 6.4 Splice result

To display splice mode, press  and then the “Splice result” menu with  button. It displays a screen to select splice result menu. The splice result menu is equipped with various functions for a user to identify and delete splice result and images.

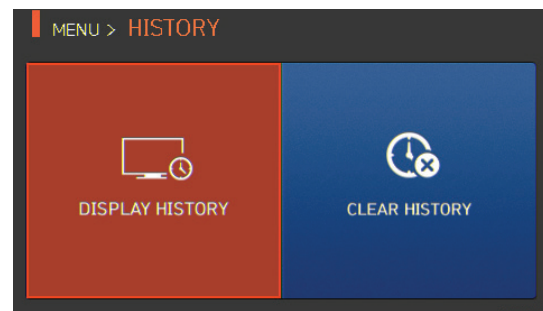
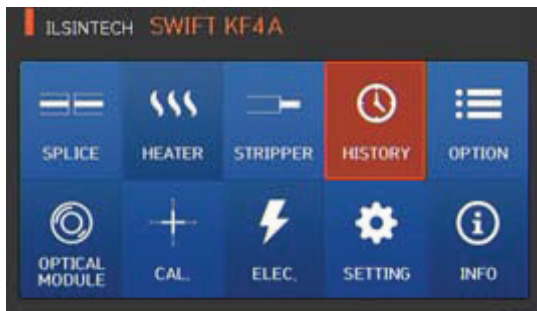

### 6.4.1 Splice result display

It can save up to 10,000 splice data and images and the user can identify them. Each page shows 7 splice data and images and it goes to the next page by pressing .

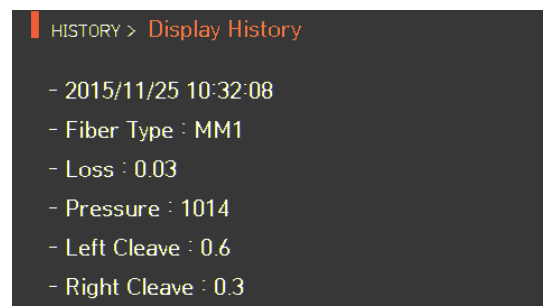
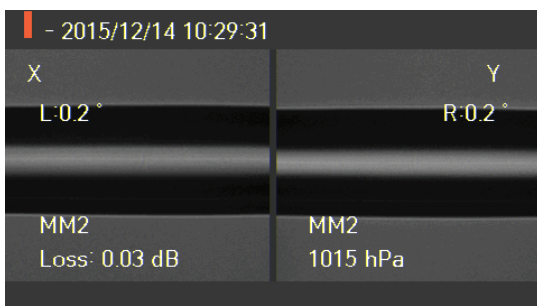
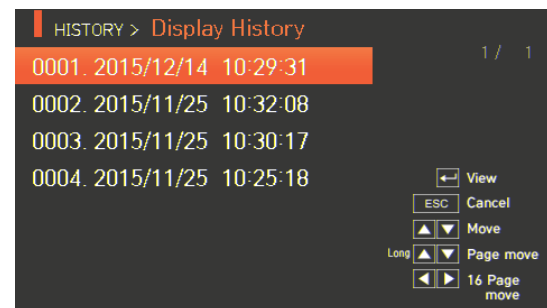
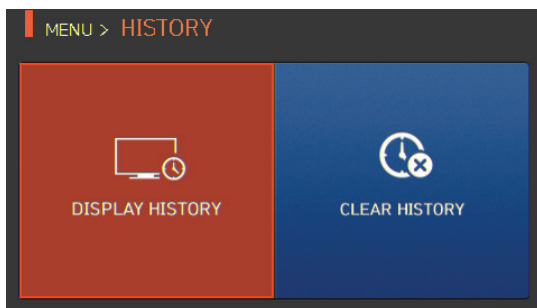

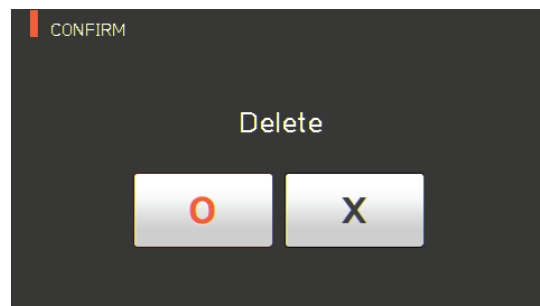
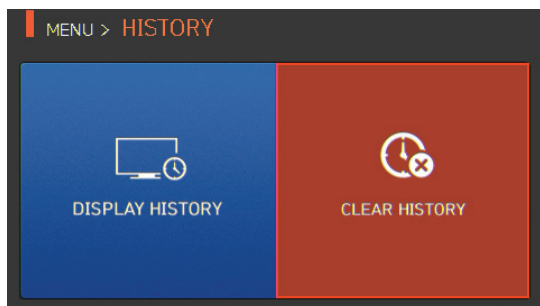

## 6.4.2 Deletion of splice result

All of the data and images can be deleted at one time.



## 6.5 Option

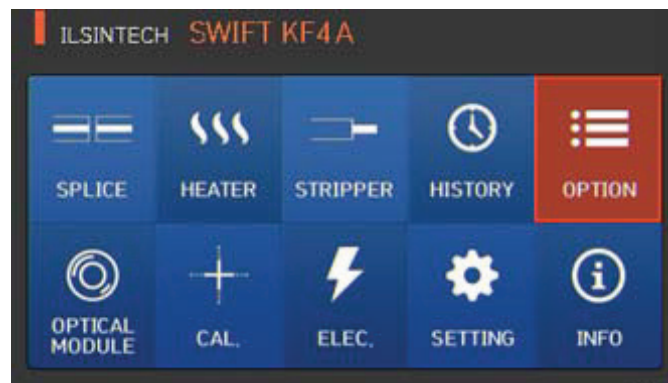

To display option menu, press  and then select “option” menu with  button. It displays a screen to select an option menu as follows. The option menu is equipped with various functions to provide a user with better environment for operation

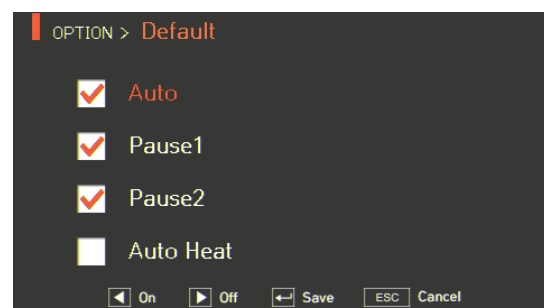
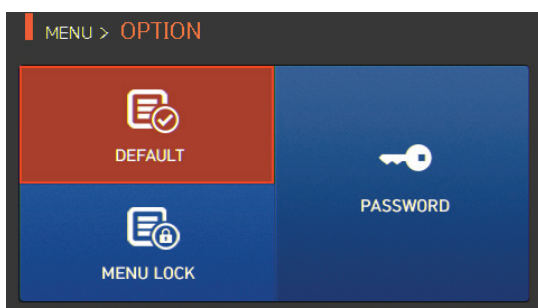

### 6.5.1 Splice operation

Splice operation consists of 4 sub-checkboxes. As the user marks a checkbox, and each function is activated.



Set value	Description
Auto	Splice automatically starts when closing the wind cover.
Pause 1	It temporarily stops after first alignment completes. Press  and it goes to the next step.
Pause 2	It temporarily stops after clad alignment completes. Press  and it goes to the next step.
Auto Heat	Heater operates automatically after splice completes.

## 6.5.2 Menu lock

This menu includes a function to restrict access to the splice mode and heater mode setting and another function to disable the deletion of the splice result. After activating this lock function, even the access to menu for menu lock can also be restricted. Password entry is required to release this restriction so a user should memorize the password. If a user forgets the password, he should send the equipment to Ilsintech to reset the password.

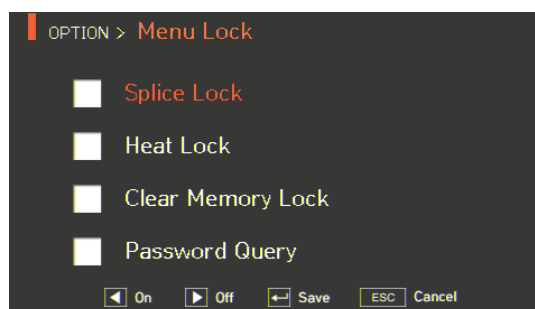
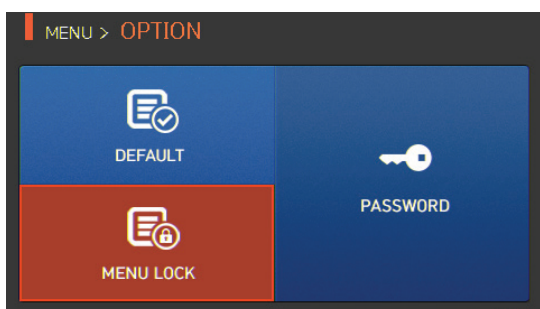

	Test item	Description
1	Splice Lock	It restricts modification on splice mode.
2	Heat Lock	It restricts modification on heater mode.
3	Clear Memory Lock	It restricts deletion of splice result.
4	Password Query	It shows a screen to enter your own password. The initial password is "1234".

### 6.5.3 Password

Password can be changed as follows.

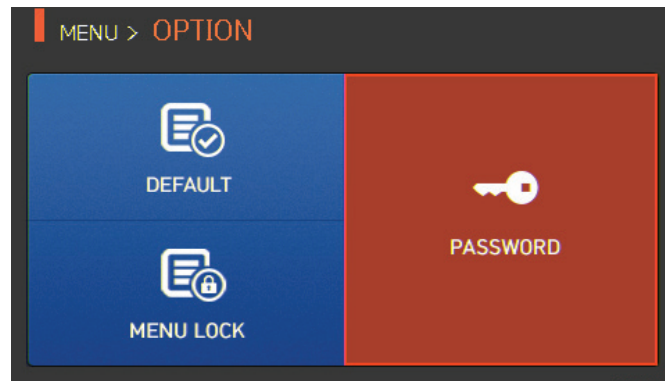

- i. Enter the current password.  
The initial password is "1234".



- ii. Enter a new password.



- iii. Enter the new password again.

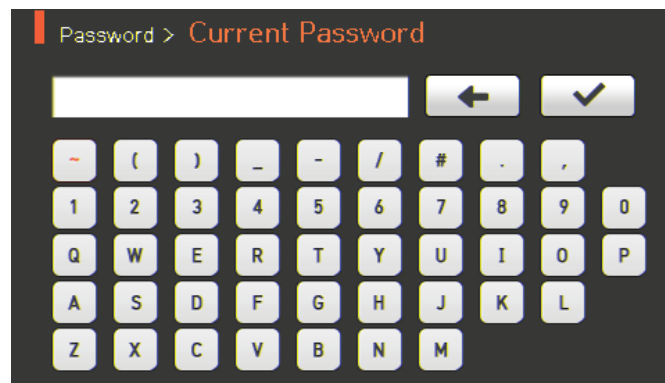

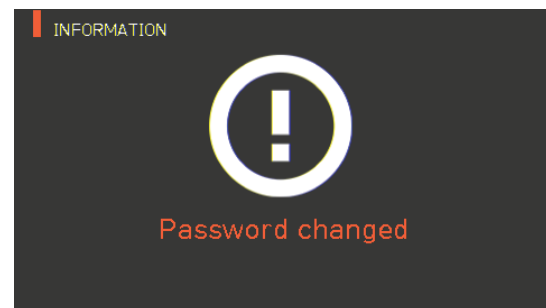
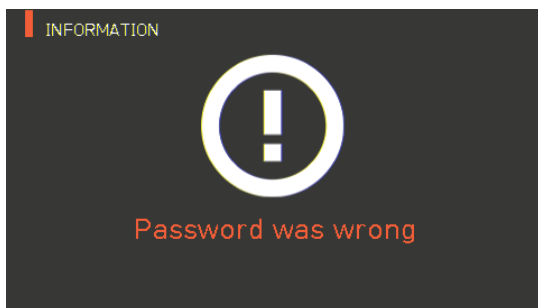

- When the entered password does not match, the following message is shown and it goes back to the previous stage.



- A user should memorize the password. If a user forgets the password, he should send the equipment to IIsintech to reset the password.

## 6.6 Optical module

To display the optical module, press  and then select “Optical module” menu with  button. It displays a screen for the optical module menu as follows. Optical module menu is equipped with functions such as information on optical power meter and V.F.L., etc.

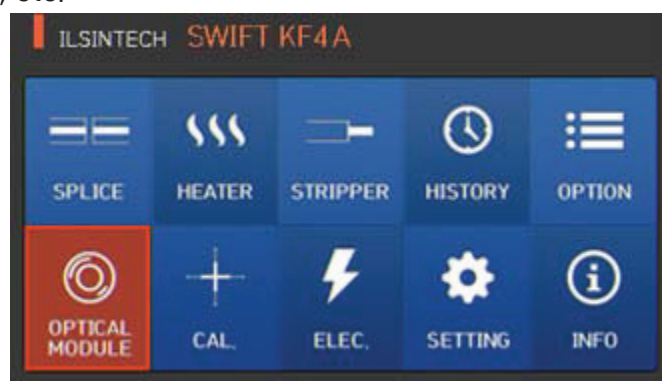

### 6.6.1 Optical power meter

Press “Optical power meter” and it shows the following screen. You can check information on optical module power meter.

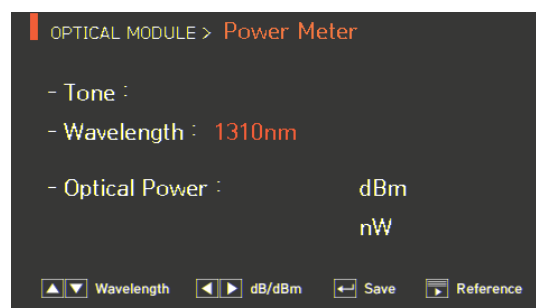
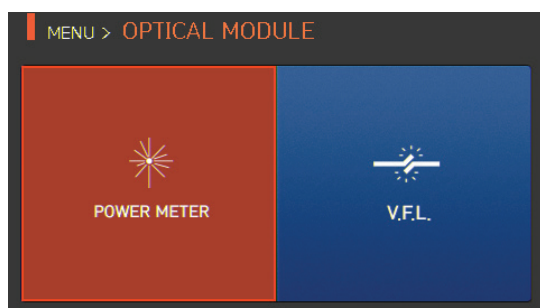

- Tone: Displaying frequency of light source
- Continuous: State turned on at all times without frequency of light source
- Others: Displaying the corresponding frequency (270, 330, 1K, 2K by unit of Hz)
- Wavelength: Displaying wavelength of light source
- Optical power: Displaying power of light source, marking default dBm and mW
- dBm/dB: Selecting which of dBm or dB to be used in displaying power of light source
  - Upon marking with dB, the reference is also marked simultaneously.
- Save: Saving measured values of light source that are currently being measured
- Ref. (Reference): Setting reference value upon marking with dB
- W/L(Wavelength): Making changes on wavelength of light source



- Menus moved with left and right keys and operation performed with the enter key

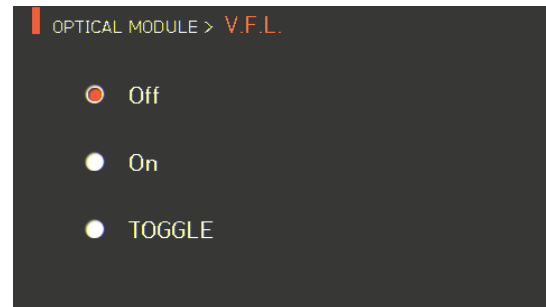
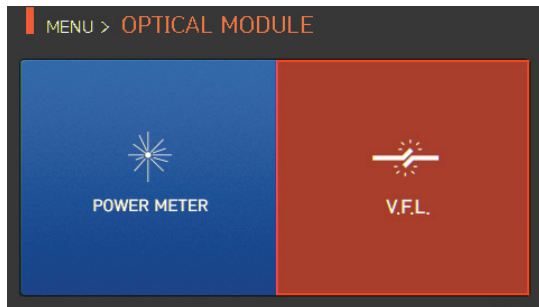

## 6.6.2 V.F.L.



- Connect SOC to V.F.L and check whether the fiber is disconnected with the disconnection check being turned on.
- Upon flickering, V.F.L is activated with 2~3 Hz.
- When you finish using V.F.L, turn it back to the off state.

Blindness can be incurred when you see the light output from V.F.L with naked eye so please be careful.

## 6.7 Calibration

To display splice mode, press  and select the “Calibration” menu with  button. It displays a screen to select the calibration menu as follows. The calibration menu is equipped with various functions such as arc amount calibration, motor operation test, etc.

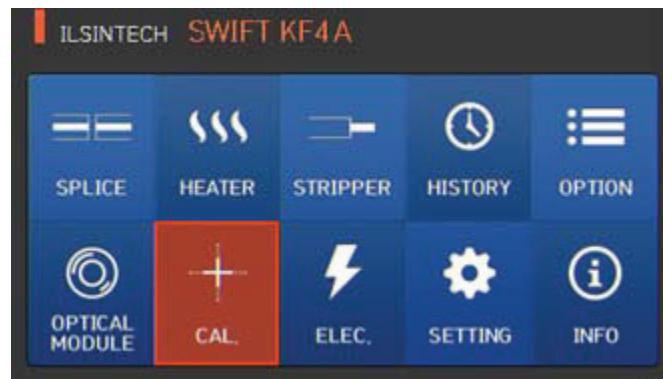

### 6.7.1 Arc calibration

Swift KF4A continuously checks if there is a change in temperature and the air pressure through each sensor. Based on such data, arc amount is automatically adjusted. A change in arc amount due to abrasion of the electrodes or the fiber splice, however, is not automatically adjusted. The central axis of arc can also be moved towards the left or right with a large amount of arc. In this case, arc calibration is required.



- When executing arc calibration, arc voltage is automatically changed into a proper value. As this value is calculated by a certain computing program, a user cannot arbitrarily change it.
- Upon arc amount calibration, SM fiber should be used.
  - i. Put a prepared SM fiber on splicer.
  - ii. Press  as follows.

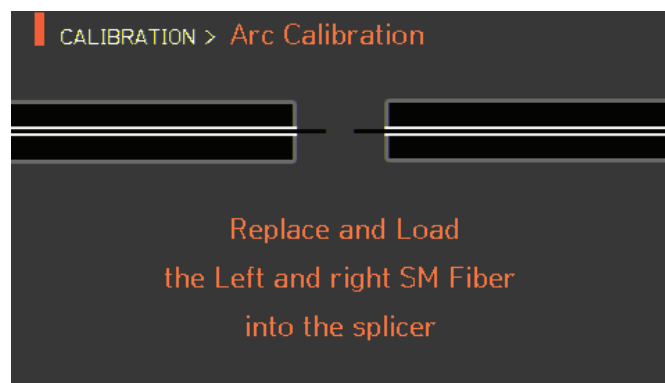

- iii. When arc calibration completes, the following screen is displayed.

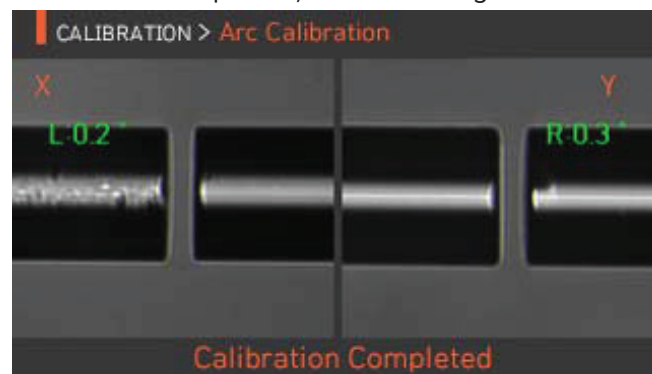

- iv. If it is necessary to stop the arc even before the arc calibration is completed, it immediately stops when pressing .

## 6.7.2 Diagnostic test

The diagnostic test is a function to facilitate dust examination, LED examination and motor test and calibration at a time.

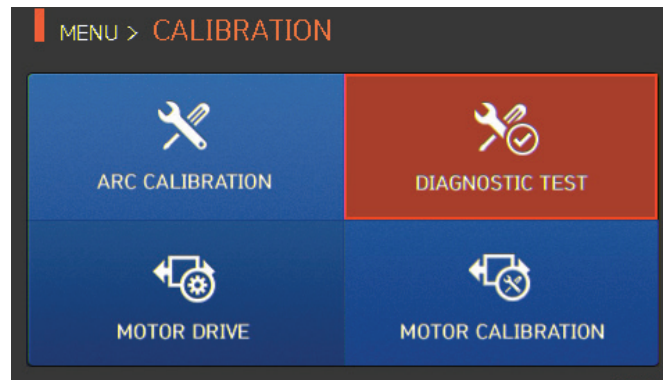





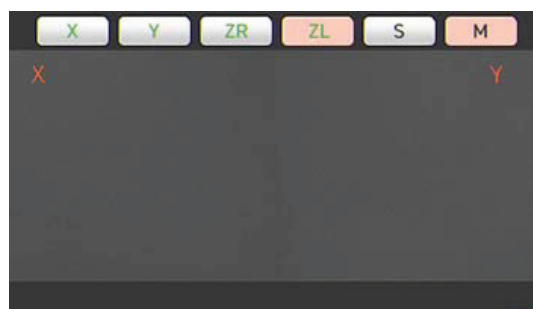
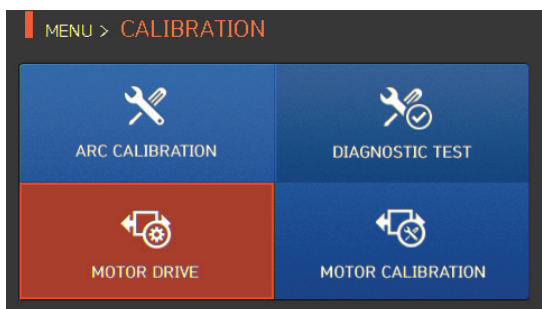

	Test item	Description
1	Dust testing	Conducts dust test without fiber.
2	LED testing	Conducts LED test without fiber.
3	Motor testing	Conducts motor test
4	Heater testing	Conducts heater test

### 6.7.3 Motor drive

Motor drive checks whether the motor operates normally in manual mode.





- i. Remove the fiber from the splicer.
- ii. Select "Motor drive" with  button.
- iii. Change the motor selection by pressing . The name of the selected motor is indicated at the top of the screen.
- iv. Operate the motor in a direction wanted by pressing  .

Motor		
X/Y	Makes fiber go bottom	Makes fiber go up
ZR	Makes right fiber go backward	Makes right fiber go forward
ZL	Makes left fiber go forward	Makes left fiber go backward
S	Moves step by step upon every press of the button.	
M	Continuously moves upon pressing the button.	

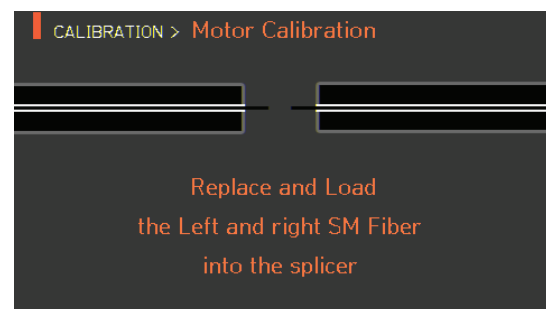
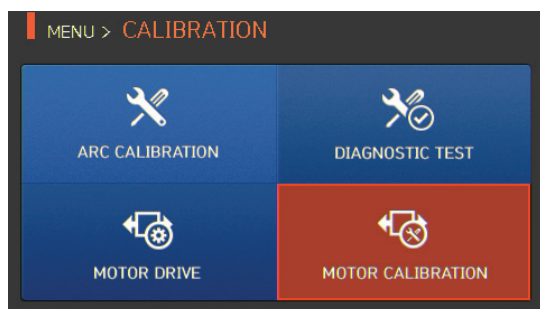

## 6.7.4 Motor Calibration

Motor setting is set on splicer as default but depending on motor setting location, splice speed may slow down. If the speed slows down during the splice operation or any abnormality is incurred while in the entering position, the motor setting can be automatically calibrated through this function.



- i. Put the fiber on the splicer.
- ii. Select "Motor calibration" with  button.
- i. If an error message is displayed after testing, immediately contact Ilsintech.
- iii. End the calibration by pressing .

## 6.8 Electrodes

To display electrodes mode, press  and then select “ELEC” menu with  button. It displays a screen to select electrodes menu as follows. For using the splicer, it should be regularly cleaned due to electrodes abrasion and precipitation of silica oxide. This menu is related to checking electrodes use count and electrodes exchange and includes 4 submenus.

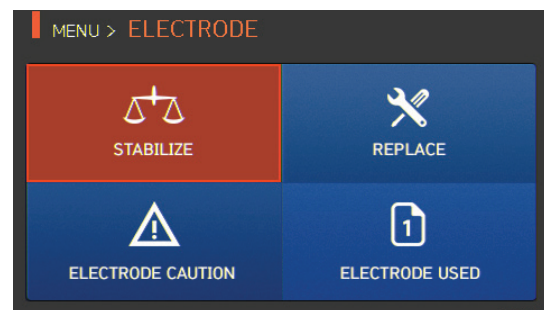
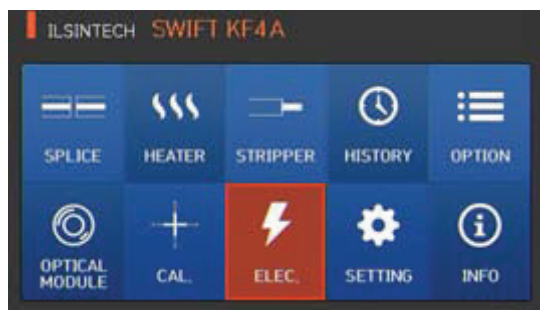

## 6.8.1 Electrodes Stabilize

Arcing can sometimes become unstable due to surroundings and consequently, the splice loss may increase. As it takes a long time to stabilize arcing when the splicer is located at low or high elevations, it is particularly important to wait for the electrodes inside to be stabilized. After replacing the electrodes, in particular, its stabilizing should be conducted.

- i. Put a prepared fiber on the splicer.
- ii. Select "STABILIZE" with  button.

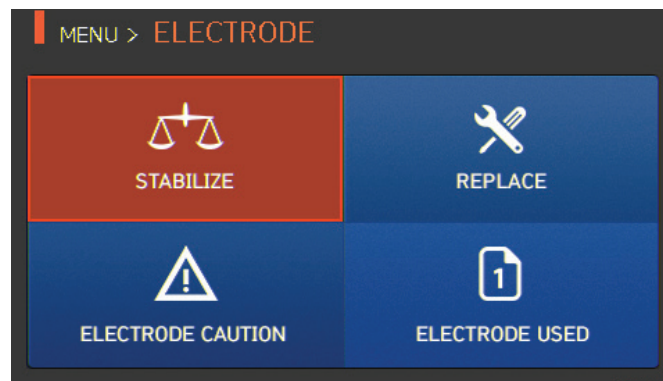

- iii. Press "OK".

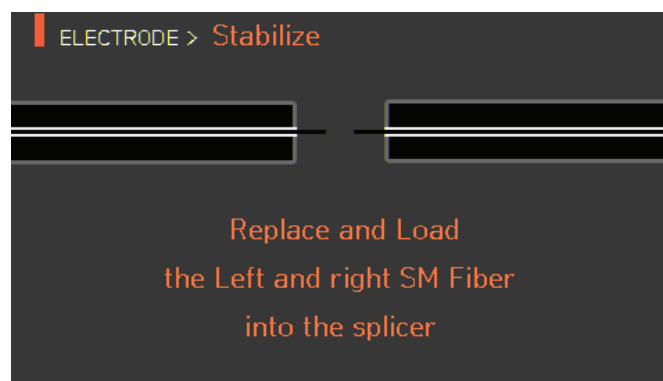

- iv. Arc is conducted 30 times in a row for electrodes stabilizing.
- v. When stabilizing completes, it displays the screen below.





- i. After stabilizing the electrodes, the arc calibration should be conducted again.

## 6.8.2 Electrodes Replace

It is recommended to replace an electrodes when the number of arc reaches 3,000 times. When it exceeds the preset number of times for replacement, a message informing electrodes replacement is displayed.

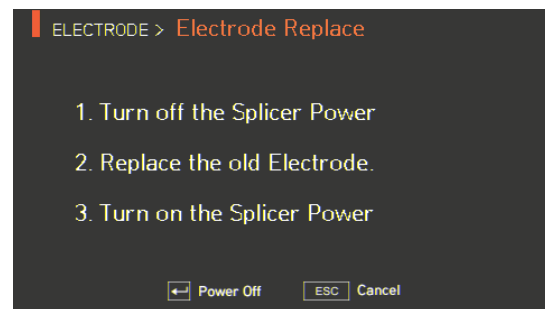
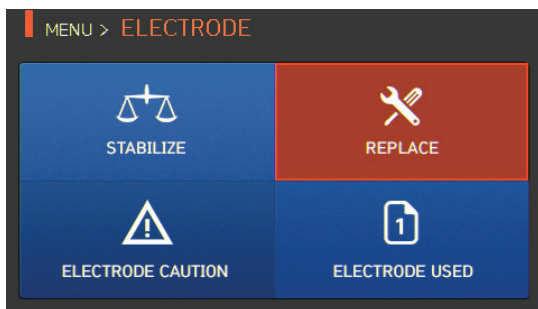

## 6.8.3 Electrodes Caution

The number of times to inform electrodes replacement is set on this menu. It is recommended to replace an electrodes when its use reaches 3,000 times.

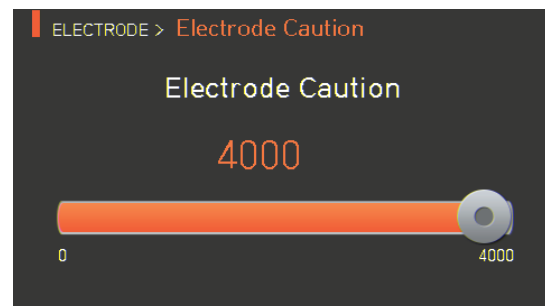
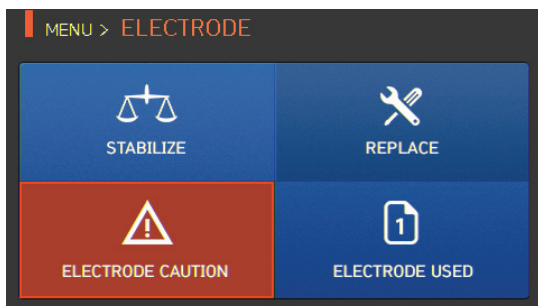

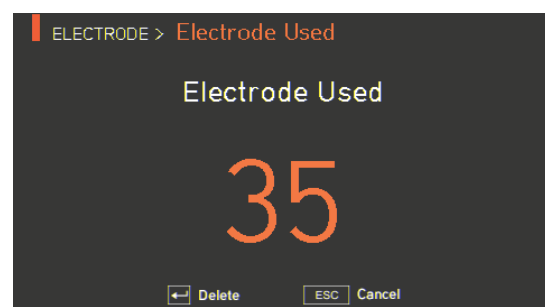
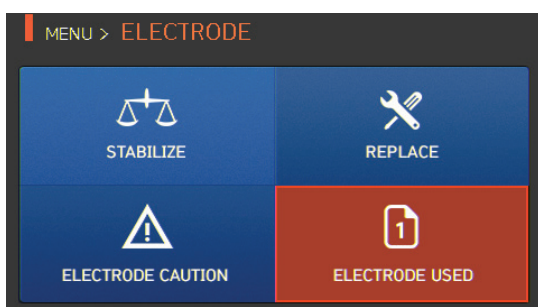

## 6.8.4 Number of Electrodes Use

It indicates the number of electrodes used as counted up to the present time.



## 6.9 Setting

To display setting mode, press  and then select "Setting" menu with  button. It displays a screen to select setting menu as follows.

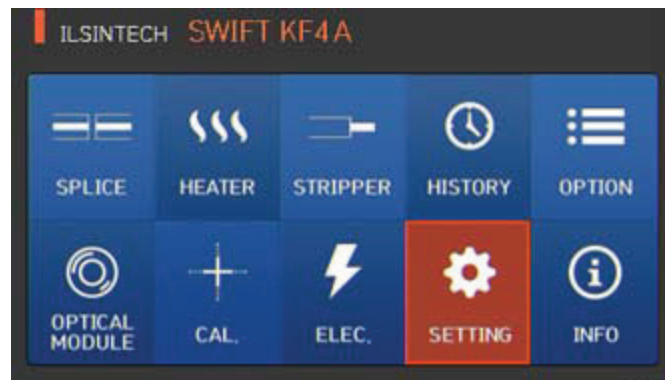

### 6.9.1 Language

A screen to select a language is displayed.

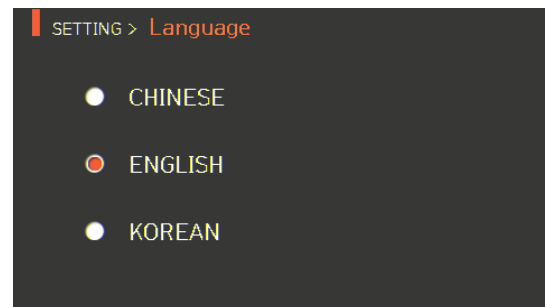
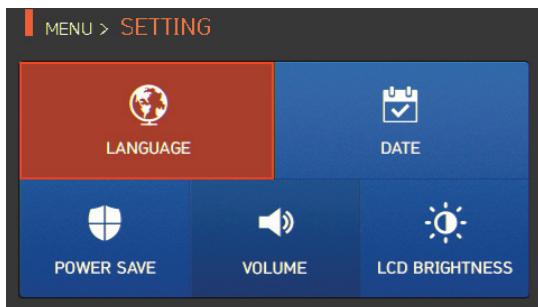

## 6.9.2 Date

A screen to set the time and date is displayed.

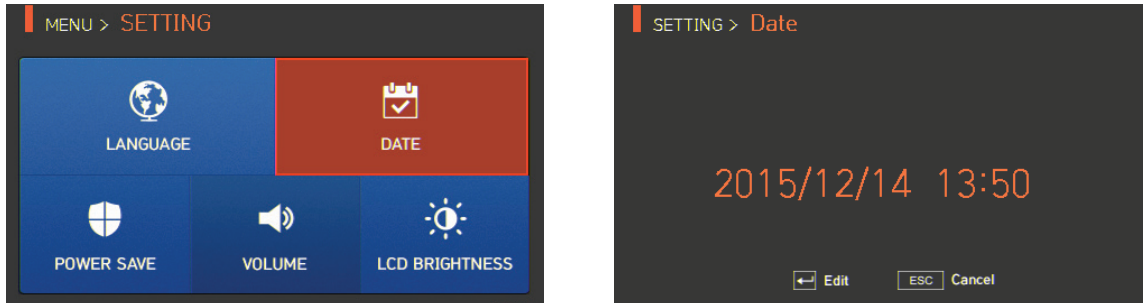

## 6.9.3 Power Save

Power save is an important function used in order to save energy. As it extends a user's operation time when operating Swift KF4A with a battery, it is recommended to use "Power Save".

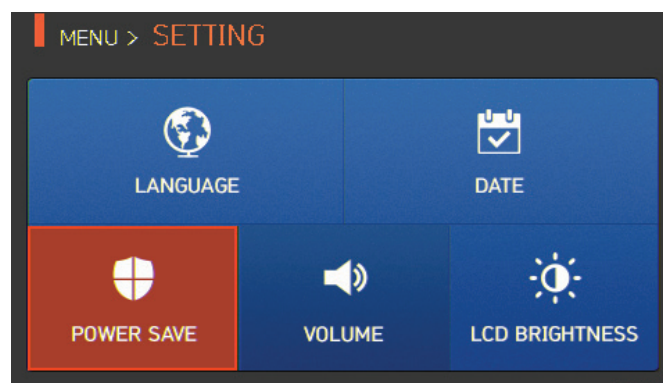

## 6.9.4 Monitor

When Swift KF4A is not used for a preset time period, the LCD screen automatically turns off. With the push of any button, the screen turns on again

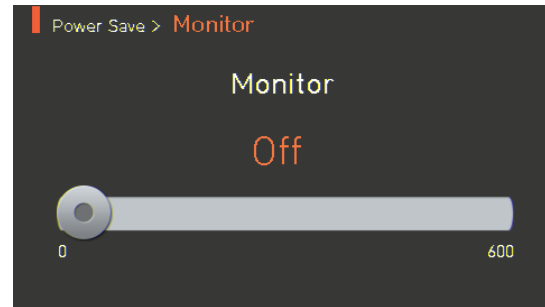
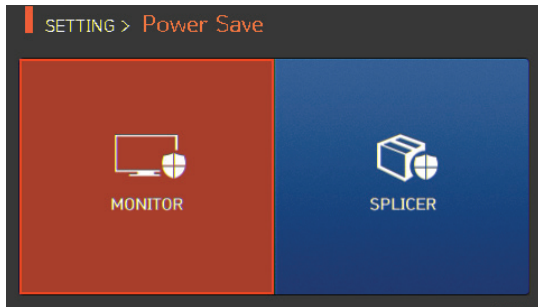

## 6.9.5 Splicer

When Swift KF4A is not used for the preset time period, power is automatically turned off.

The power is turned on again only when pressing

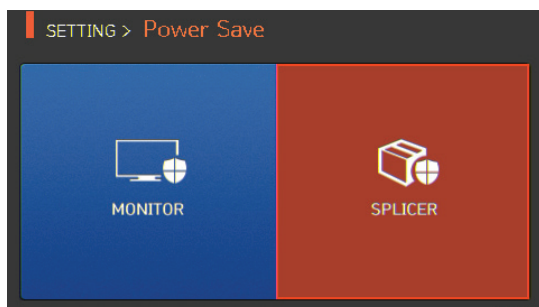

## 6.9.6 Volume

It adjusts the loudness of the buzzer sound.

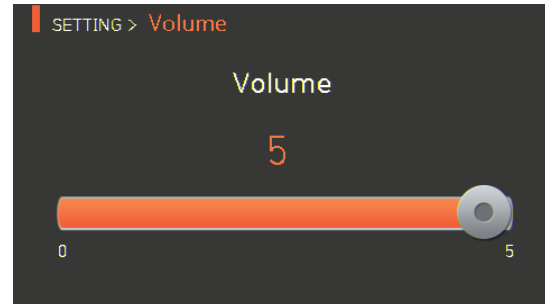
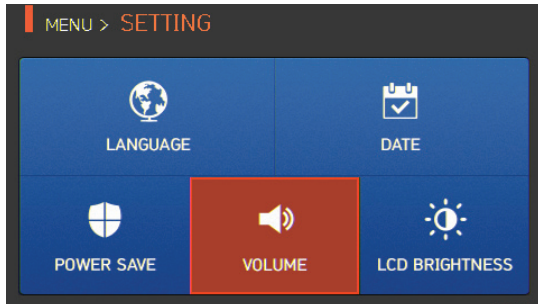

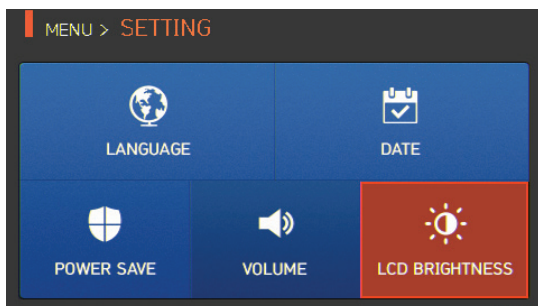

## 6.9.7 LCD Brightness

It adjusts LCD Brightness.



## 6.10 Information

To display information mode, press  and select “INFO” menu with  button. It displays a screen to select information menu as follows. This menu provides information for maintenance.

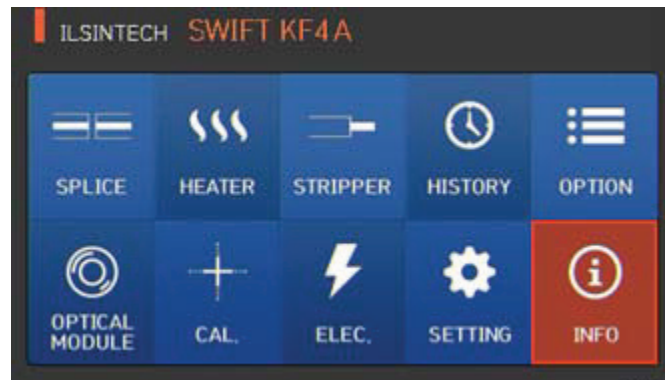

### 6.10.1 Maintenance

Press “Maintenance” and it displays the screen below.

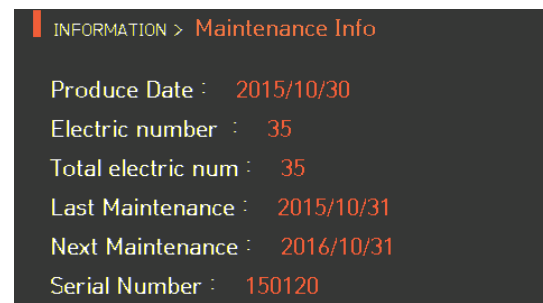
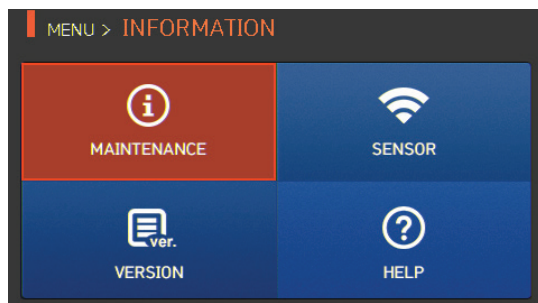

Item	Description
Produce Date	Describes the date of the equipment’s manufacture. (year, month, day)
Electric number	Indicates the number of arc after the electrodes replacement.
Total electric num	Indicates the total amount of arc after the product’s release.
Last Maintenance	Indicates the date of recent maintenance.
Next Maintenance	Indicates the next maintenance date.
Serial Number	Indicates serial number given to the equipment.

## 6.10.2 Sensor

Press the “Sensor” and it displays the screen below.

Splicer has sensors to check the temperature, air pressure

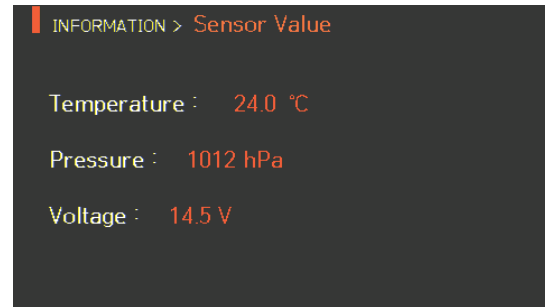
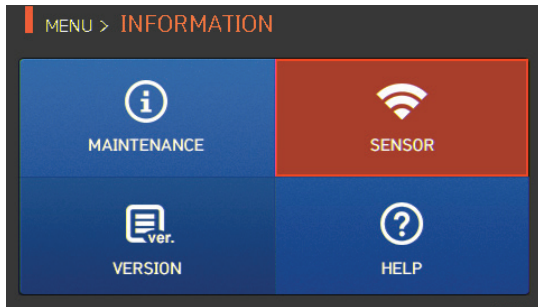

## 6.10.3 Version

Press “Version” and it displays the screen below.

The version can be upgraded easily by connecting to a PC and using the DataSync program (PC Program).

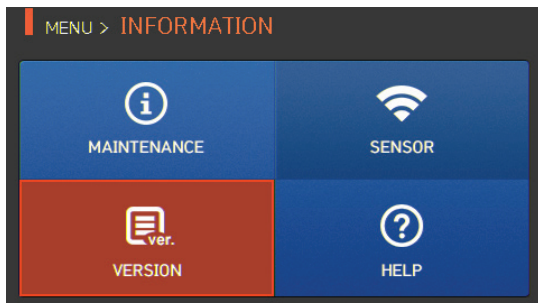



## 6.10.4 Help

Press “Help” and it displays the screen below.

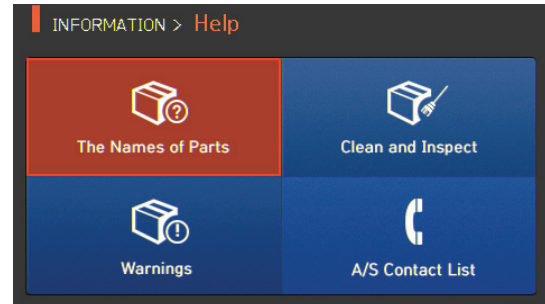
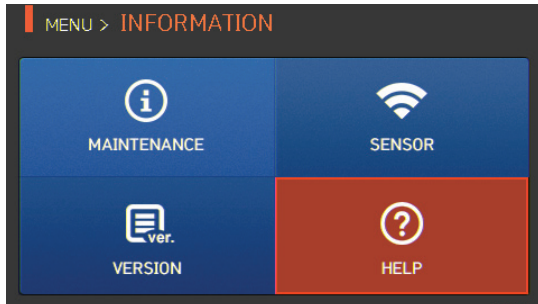

Item	Description
The Name of Part	Names of each component on Swift KF4A
Clean and Inspection	Cleaning and inspection method
Warnings	Important warnings
A/S Contact List	Contact information for warranty

## VII. Error message

### 7.1 Too Dirty Fiber

It is an error message generated when the fiber prepared for splicing contains foreign substances exceeding a normal level.

Solution: Repeat splice after cleaning the fiber.

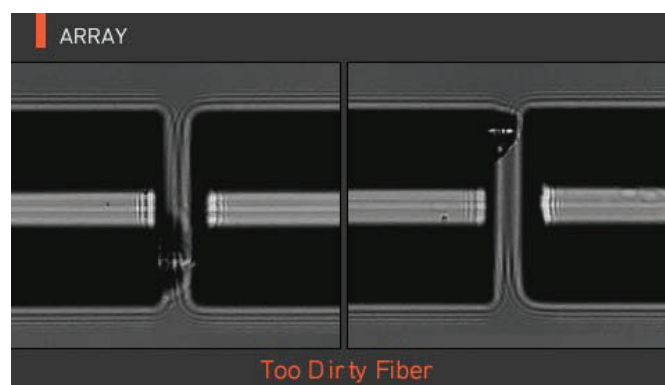

### 7.2 Replace Fiber.

It is an error message generated when the fiber is not located in the right location or there is a foreign substance on the object lens or reflector.

Solution: Press **RESET** and put the fiber on the right location again. Clean the object lens and reflector.



## 7.3 Too Long Fiber.

It is an error message generated when the fiber is located too close to the electrodes; object lens or reflector is dirty or the LED is not sufficiently bright enough.

Solution: Press **RESET** and put the fiber on a right location yet again. Clean the object lens and reflector. Conduct LED test. If an error occurs upon performing the LED test, contact Ilsintech.

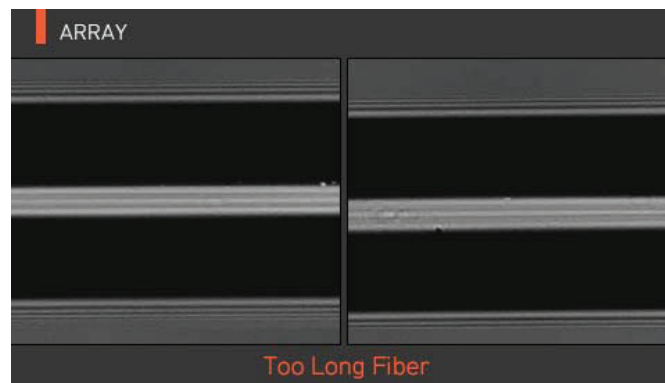

## 7.4 Fiber Over Angle

It is an error message generated when the cleaved angle of the fiber is measured as bigger than the limit.

Solution: Check the state of the fiber cleaver. Check the cleaved angle limit.

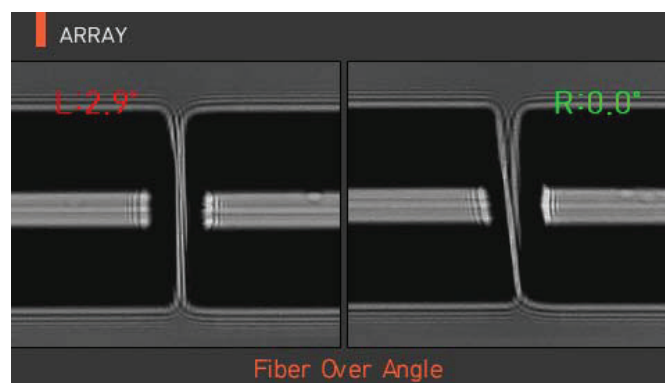

## 7.5 Loss Limit Over.

It is an error message generated when the estimated loss value is bigger than the preset loss factor limit.

Solution: Check the loss factor limit.



## 7.6 Fiber Thin Error

It is an error message generated when the spliced point becomes thinner than the standard after splicing.

Solution: Make an adjustment to shorten the pulling length of the pulling splice. Check whether the arc amount or arc time is set as too large or too long respectively.

## 7.7 Fiber Thick Error

It is an error message generated when the spliced point becomes thicker than the standard after splicing.

Solution: Reduce the overlap set value. Check whether the arc amount or arc time is set as too small or too short respectively.

## 7.8 Bubble error

It is an error message generated when there are bubbles or spots being generated on spliced point after splicing.

Solution: Examine the fiber cleaver. Clean the V-Groove. Examine the electrodes.

## 7.9 Cleaved Surface Error

It is an error message generated when the cut surface of fiber is of poor quality.

Solution: Check the condition of the fiber cleaver. Cut the fiber ~~yet~~ again.

## VIII. Splicing problem solving

---

### 8.1 When loss is high

- Any dust or foreign substance on the fiber surface may incur poor splice.
  - Clean the fiber surface sufficiently.
  - Do not clean the fiber after cleaving to prevent dust from being gathered on the fiber cross section.
  - Do not push in the fiber when putting it on V-Groove.  
The fiber should be placed from the top to bottom.
  
- Any foreign substance on V-Groove hinders the correct alignment.
  - Keep the V-Groove clean at all times.
  
- Electrodes bad condition
  - When an electrodes contains an abrasion or its tip is bent and dirty, replace the electrodes.
  
- Arc amount and arc time are inappropriate.
  - Check the setting of arc amount and arc time to reset them with proper values.
  - Without any great change, the initially set values are the most appropriate ones.
  
- Inappropriate splice mode
  - Check whether appropriate splice mode is selected for the fiber.

## 8.2 Abnormal splicing operation

- Alignment operation is repeated.
  - Open the wind cover again and then close.
  - If discontinues, open the wind cover, press  and then turn off the power. Then contact Ilsintech.
  
- The error message “Too Long Fiber” is continuously generated.
  - Turn off the power and contact Ilsintech.

# IX. Problem occurrence and question

---

## 9.1 Power

- Power is not turned on by pressing  .
  - Check whether the screen is turned off with the switch being pressed for about 1 second.
- Cannot continue splicing after several times of splices even with the fully charged battery.
  - Power is quickly consumed when “Save mode” is not in use. Refer to the [Save Mode] and supply the power appropriately at all times. When the battery is not used for excessively long period time, recharge it.
  - If the battery’s life ends for long-term use, replace it with a new one. As the battery operates using chemical reaction, its wattage drops with low temperature and it rapidly drops particularly with temperatures below zero. As the splice current consumption goes up with high temperature, battery’s power consumption accelerates.
- LED is not turned on upon charging.
  - Disconnect the charter’s AC power cord and connect the DC cord to the charging jack.  
Connect the AC power cord after 10~15 seconds. Then the battery’s LED is turned on red and charging starts.
- Remaining battery is not indicated.



- Charge the battery.
- Remaining battery is not well displayed.
  - Remaining battery display is for reference.

## 9.2 Splice



- Error message is displayed on the screen.
  - Refer to the [Error message list].
- Splice loss is high or irregular.
  - Clean V-Groove, V-Block, reflector and object lens by referring to [Maintenance of splice quality]. Replace electrodes by referring to [Electrodes replace]. Refer to the “High estimated loss” from [Error message list].
  - If fiber warps or is bent, place the fiber bent direction to face the bottom. Splice loss varies depending on cleaving angle, arc condition and cleanliness level of fiber. Splice loss is still high or irregular even after implementing the above recovery measures, contact to Ilsintech. Annual maintenance is required to keep splice optimal quality.
- Monitor is suddenly turned off.
  - Refer to [Monitor sleep mode menu].
- Power is suddenly turned off.
  - Refer to [Splicer sleep mode menu].
- Either arc amount or arc time cannot be changed.
  - On SM, NZ, MM or AUTO mode, either arc amount or arc time cannot be changed. Implement [Arc Calibration], and the arc amount on



these modes is properly maintained. When used on another mode, arc amount and arc time are automatically set to prevent their alteration.

- I'd like to set pause.
  - Refer to [Option menu].
- I'd like to indicate cleaved angle, fiber angle and clad deviation.
  - Refer to [Option menu].
- Estimated splice loss and measured splice loss does not match.
  - The estimated splice loss is a calculated value so it should be used only as a reference.

### 9.3 Sleeve heater

- Fiber protecting sleeve is not contracted completely.
  - Increase the heating time. Refer to [Heater mode edition].
- Heater is overheated.
  - Stop the heater by pressing , turn the power off and then contact IIsintech.
  - If the protecting sleeve melts and it sticks to the heater cover, remove it by pushing it with a cotton swab.
- I'd like to initialize heater mode's heating condition.
  - Refer to [Heat mode edition].
- I'd like to cancel heater in the middle of operation.
  - Heater operation cannot be canceled by pressing . Cancel it by pressing  once again.

### 9.4 Others

- I'd like to restrict splice mode and heater mode setting.
  - Refer to [Menu lock].
  
- Splice mode's arc amount does not change even after [Arc calibration].
  - The internal standard arc amount is calibrated. Therefore, the arc amount of each splice mode does not change.
  
- I forgot the password.
  - Contact UCL Swift

## X. Warranty and Repair

---

### Responsibility limit

Ilsintech guarantees its product regarding the product's material and flaws from the manufacturing. With normal use and service, we guarantee the entire hardware of the product for the term of guarantee. When a problem is incurred during the term of guarantee, the product is to be repaired or exchanged free of charge by Ilsintech's own judgment. When a flaws or damages are incurred for any of the reasons listed below, the repair expense may be charged to the customer even under warranty.

- i. Natural disaster
- ii. Abnormal voltage supply
- iii. User's careless handling
- iv. Product handling with disregard on working procedure or directions written on instructions for use
- v. Consumables (electrodes, etc)

### 10.1 Information necessary for repair

Before sending the product, contact UCL Swift first.

- i. Give us following information by attaching a paper to the product.  
(Name, Department, Company, Address, Contact information, FAX, E-MAIL)
- ii. Product serial number
- iii. Product condition and problem incurred, Error Information
- iv. Product handling with disregard to working procedure or directions written on instructions for use

## 10.2 Transportation

As Swift KF4A is a high-precision device, please send it along in the carry case to protect it from humidity, vibration and shock. When requesting the product repair, send its components as well by putting them in the carry case.

## 10.3 Repair

Newly made splice mode or splice result may be or may be not deleted depending on the repair work performed.

# Product Warranty

Product name		SWIFT KF4A	
Manufacture no.			
Date of purchase			
		Tel.	
Customer	Name		
	Address		

## Warranty

1. This product is manufactured through strict quality management and inspection.
2. This product guaranteed for one year over defective parts from its date of purchase.
3. Present this product warranty card when repair is required for the product.
4. As this product is a high-precision device, please carry it in the carry case at all times to protect it from humidity, vibration and shock.

## Charged service

In the following cases, a service fee (repair, component and travel expenses) is charged even under warranty.

1. Breakdown or damage due to natural disasters
2. Breakdown or damage due to abnormal voltage supply
3. Breakdown or damage due to user's careless handling
4. Breakdown or damage due to product handling with disregard to the working procedure or directions written on instructions for use
5. When the seal is damaged

---

❖ When maintenance is required, contact Ilsinthe or local sales representatives